



J10 twin (EA/SA/INTA)

Instructions for Use



Additional online content

Tap, click or scan the QR code to access additional online resources.

There are video tutorials to help you operate your J10 twin.



jura.com/support-j10twin

Your J10 twin

1	Control elements	3
2	For your safety	4
	Comply with the instructions for use	4
	Proper use	4
	User limitations	4
	Use by children	4
	What to do in the event of damage	4
	Preventing damage	5
	Danger of electric shock	5
	Danger of burns, scalding and injury	5
3	Preparing and using for the first time	6
	Setting up the machine	6
	Filling the bean container	6
	Determining the water hardness	6
	First-time use	6
	Managing your J10 twin – the JURA Cockpit	8
	Connecting milk	8
	Connect the machine with J.O.E.® - your JURA app	9
	Coffee Timer	9
4	Preparation	9
	Espresso and coffee	10
	Preparation with preselection (Aroma Selection and Speciality Selection)	10
	Sweet latte (prepared with syrup attachment)	11
	Cold Brew	11
	Latte macchiato, cappuccino and other speciality coffees with milk	12
	Milk and milk foam	12
	Americano and lungo	13
	Espresso doppio	13
	Ground coffee	13
	Hot water	14
	Adjusting the grinder	14
	Adjusting the product settings	14
5	Daily operation	15
	Switching the machine on and off	15
	Filling the water tank	15
	Maintenance actions	15
6	Machine settings	16
7	Maintenance	17
	Rinsing the machine	17
	Automatic milk system rinsing	17
	Cleaning the milk system	17
	Dismantling and rinsing the professional fine foam frother	18
	Inserting/changing the filter	19
	Cleaning the machine	20
	Descaling the machine	21
	Descaling the water tank	22
	Cleaning the bean container	22
8	Display messages	23
9	Troubleshooting	23
10	Transport and environmentally friendly disposal	24
	Transport / Emptying the system	24
	Disposal	24
11	Technical data	24
12	Index	25
13	JURA contact details / Legal information	26

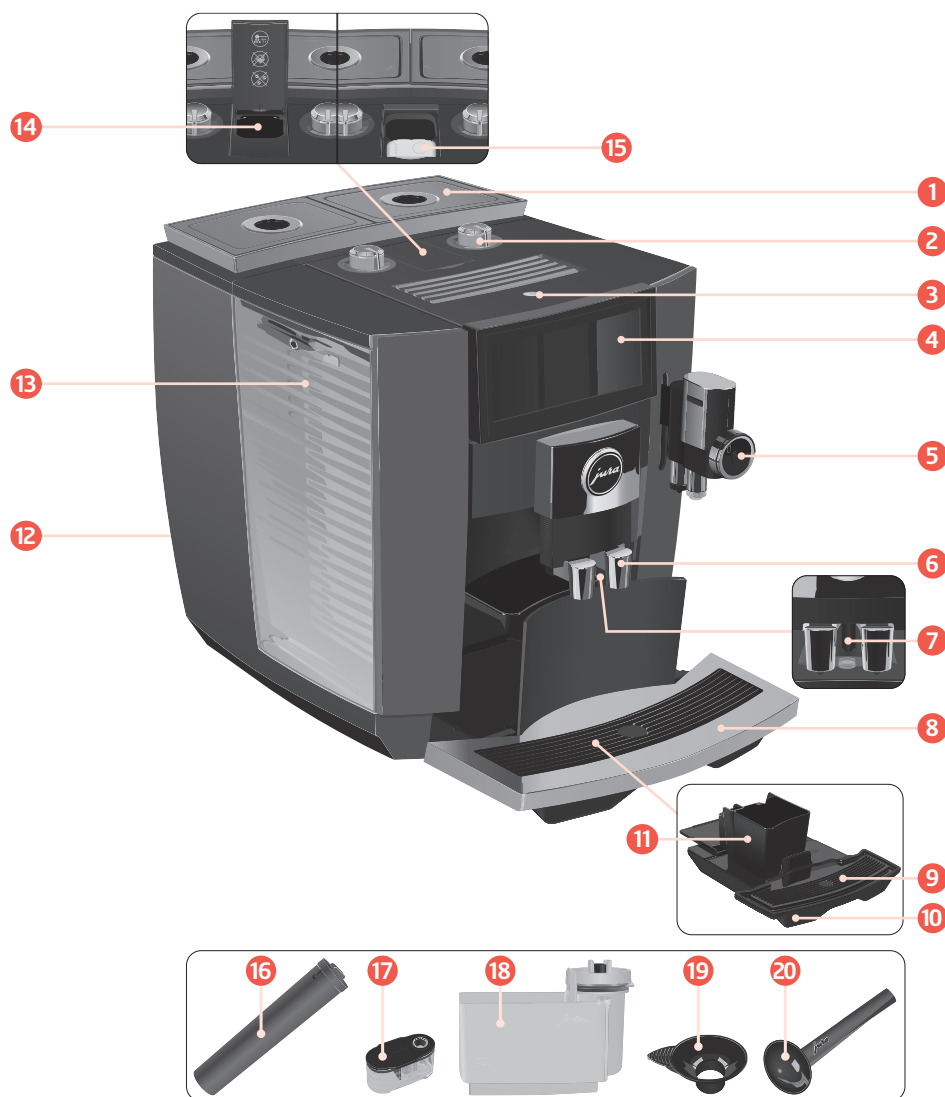



- 1 Bean container with aroma preservation cover
- 2 Grinder adjustment switch
- 3 On/Off button 
- 4 Touch display
- 5 Milk system with professional fine foam frother (height-adjustable)
- 6 Coffee spout (height-adjustable)
- 7 Hot-water spout
- 8 Cup grille with aperture
- 9 Insert for drip tray
- 10 Drip tray
- 11 Coffee grounds container
- 12 Mains cable (permanently connected or plug-in)
- 13 Water tank with cover
- 14 Powder chute for ground coffee with cover (removable)
- 15 Service socket with JURA Wi-Fi Connect (under cover)
- 16 Filter casing
- 17 Syrup attachment
- 18 Container for milk system cleaning
- 19 Filler funnel for ground coffee
- 20 Measuring spoon for ground coffee

2 For your safety

Comply with the instructions for use

Before using the machine, read these instructions for use thoroughly and completely and comply with the instructions they contain. Keep these instructions for use close to the machine and pass them on to the next user.

Failure to observe the instructions for use may result in serious injuries or damage to property. Safety information is therefore indicated as follows:

 WARNING	Indicates circumstances that may result in serious injuries or death.
 CAUTION	Indicates circumstances that may result in minor injuries.
CAUTION	Indicates circumstances that may result in damage to property.

Proper use

The machine is intended for private domestic use. It should only be used for coffee preparation and to heat milk and water. Use for any other purpose will be deemed improper.

User limitations

People, including children, who

- do not have the physical, sensory or mental capabilities to use the machine safely or
- are inexperienced or lack knowledge

must be supervised by a responsible person when using it, or must be instructed in how to use it correctly.

When using the CLARIS Smart+ filter cartridge or a JURA Wi-Fi Connect, wireless connections are established. Specific details on the frequency band used and the maximum transmission power can be found in the '11 Technical data' section.

Use by children

Children must be able to recognise and understand the potential dangers arising from incorrect use:

- Keep **children under the age of 8** away from the machine, or supervise them constantly.
- **Children aged 8 and over** may only operate the machine without supervision if they have been instructed in how to use it safely.
- Children may not clean or service the machine unless supervised by a responsible person.
- Do not allow children to play with the machine.

What to do in the event of damage

Never use a damaged machine or mains cable. This could result in fatal electric shock.

- In the event of signs of damage, disconnect the machine from the mains. To do this, first switch the J10 twin off with the On/Off button . Only then should you remove the mains plug from the power socket.
- Replace a damaged **plug-in mains cable** with an original JURA mains cable. Unsuitable mains cables may result in consequential damage.
- Only permit authorised JURA service centres to carry out **repairs to the machine** and the **permanently connected mains cable**. Unsuitable repairs may result in consequential damage.

Preventing damage

To avoid damage to the machine and the mains cable:

- The J10 twin must not be placed in a cabinet when in use.
- Do not use the J10 twin and the mains cable near hot surfaces.
- Do not allow the mains cable to rub against sharp edges and ensure that it does not become trapped.
- Never allow the mains cable to loosely hang down. The mains cable could pose a tripping hazard or become damaged.
- Protect the J10 twin from weather and direct sunlight.
- Only connect the J10 twin to a mains voltage corresponding to that stated on the rating plate. The rating plate is located on the underside.
- Connect the J10 twin directly to a domestic power socket. Using multi-socket adapters or extension cords may cause overheating.
- The surface of the heating element and outer enclosure remains hot after use and the outside of the appliance may retain heat.
- Do not use alkaline or alcohol-based cleaning agents; only use mild cleaning agents and a soft cloth.
- Do not use any coffee beans treated with additives or caramelised coffee beans.
- Only fill the water tank with fresh, cold, non-carbonated water.
- Switch the machine off with the On/Off button  if you are going to be absent for a longer period of time and remove the mains plug from the power socket.
- Only use original JURA maintenance products. Use of products that are not explicitly recommended by JURA could damage your J10 twin.

Danger of electric shock

Water conducts electricity. Do not bring water and electricity into contact with one another:

- Never touch the mains plug with wet hands.
- Do not immerse the J10 twin and/or mains cable in water.
- Do not put the J10 twin or any individual parts in the dishwasher.
- Before cleaning, switch the J10 twin off with the On/Off button . Always wipe the J10 twin with a damp cloth rather than a wet one, and protect it from prolonged exposure to water splash. The J10 twin must not be cleaned with a jet of water.
- The J10 twin is not suitable for installation on a surface where a jet of water can be used.

Danger of burns, scalding and injury

- Do not touch the spouts during operation. Use the handles provided.
- Optionally, your J10 twin can be remotely operated using mobile devices. When preparing a product or initiating a maintenance programme, make sure that other people are not put at risk – for example, through contact with the spouts.
- Be careful to ensure that the fine foam frother is correctly installed and clean, otherwise the fine foam frother (or parts of it) may come loose.

3 Preparing and using for the first time

Setting up the machine

- ▶ Choose a spot for your J10 twin which protects the machine against overheating. Ensure that the ventilation slots are not covered.

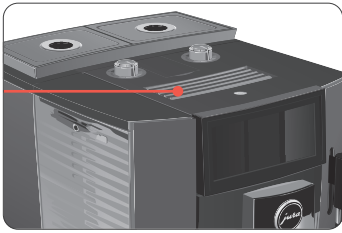

- ▶ Place the J10 twin on a horizontal surface that is not sensitive to water.

Filling the bean container

The aroma preservation covers on the bean containers ensure that the aroma of the beans is retained for longer.

CAUTION

Coffee beans which have been treated with additives (e.g. sugar), ground coffee or freeze-dried coffee will damage the grinders.

- ▶ Only use roasted, untreated coffee beans to fill the bean container.
- ▶ Remove the aroma preservation cover.
- ▶ Fill the bean container with coffee beans and close the aroma preservation cover.

Determining the water hardness

When you use the machine for the first time, you must set the water hardness. If you know the hardness of your water, go straight to the next section. If you do not know the water hardness, you can find this out first:

- ▶ Hold the Aquadur® test strip supplied under running water for one second. Shake off the water.
- ▶ Wait for about 1 minute.
- ▶ You will then be able to read the degree of water hardness from the discolouration of the Aquadur® test strip and the description on the packaging.

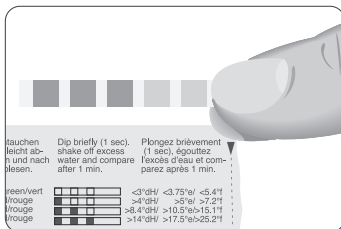

First-time use

⚠ WARNING

If the machine is operated with a defective mains cable, there is a danger of potentially fatal electric shock.

- ▶ Never use a machine which is damaged or has a defective mains cable.

CAUTION

Milk, sparkling mineral water or other liquids can damage the water tank or the machine.

- ▶ Only fill the water tank with fresh, cold water.

Precondition: The bean containers have been filled.

- ▶ For machines with a **plug-in** mains cable: Connect the mains cable to the machine.
- ▶ Insert the mains plug into a power socket.
- ▶ Press the On/Off button  to switch the J10 twin on.

'Sprachauswahl' / 'Deutsch'

- ▶ To display other languages, tap with your finger on < or > until the desired language is in focus (e.g. 'English').
- ▶ Touch 'Save'.
✓ appears briefly on the display.

'Unit' / 'oz'

i To switch between **ml** and **oz**, tap < or >.

▶ Touch 'Save'.

✓ appears briefly on the display.

'Water hardness'

i Please refer to the section above for a description of how to determine the water hardness.

▶ Touch < or > to change the water hardness setting.

▶ Touch 'Save'.

✓ appears briefly on the display.

'Insert filter'

▶ Remove the water tank and rinse it with cold water.

▶ Open the filter casing.

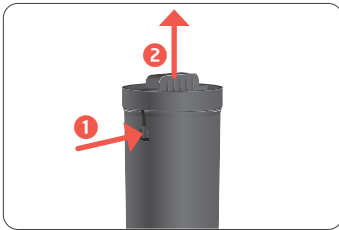

▶ Insert the CLARIS Smart+ filter cartridge.

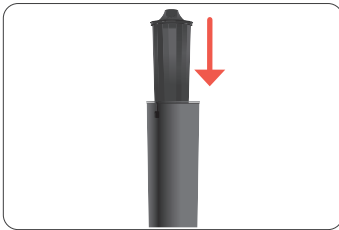

▶ Close the filter casing.

▶ Insert the filter casing into the water tank.

▶ Turn the filter casing clockwise until it audibly clicks into place.

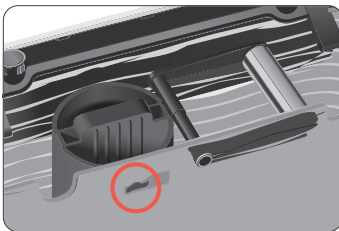

▶ Fill the water tank with fresh, cold water and reinsert the tank.

i The machine automatically detects that you have just inserted the filter cartridge.

'Filter operation' ✓

'Filter is being rinsed', water flows directly into the drip tray.

'System is filling', water flows out of the hot-water spout.

'Empty drip tray'

▶ Empty the drip tray and put it back into the machine.

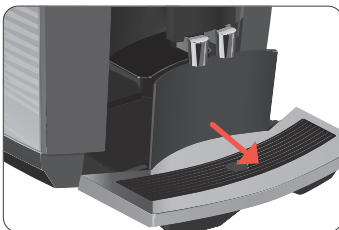

'Connections' / 'Wi-Fi connection'

3 Preparing and using for the first time

- ▶ If necessary, scan the QR code with your mobile device to download the JURA app (J.O.E.®).









- i** If you would like to connect the J10 twin to your home network, touch **'Connect'** and follow the instructions on the display. You can also establish the connection later on (in the machine settings under **'Connections'**).
- ▶ Touch **'Next'**.
'Connections' / 'Connect accessory'
- i** You have the option of connecting the J10 twin to the JURA Cool Control milk cooler (wireless connection). To do this, touch **'Connect'** and follow the instructions on the display.
- ▶ Place one receptacle under the coffee spout and another under the fine foam frother.



- ▶ Touch **'Next'**.
'Machine is rinsing' / 'Milk system is being rinsed'
The start screen is displayed. Your J10 twin is ready for use.

Managing your J10 twin – the JURA Cockpit

The **JURA Cockpit** allows you to manage your J10 twin. Touch  at the top to access the JURA Cockpit.

Symbol	Meaning
	'Machine settings' area (green)
	'Maintenance' area (blue)
	Filter mode
	The 'Coffee Eye' function (for cup detection) is enabled
	Run a self-diagnosis to check the maintenance status of your J10 twin
 (white)	Your J10 twin is connected to the network and/or Cool Control via JURA Wi-Fi Connect
 (red)	No connection to the Wi-Fi network

Connecting milk

Your J10 twin creates fine, creamy, feather-light milk foam with a perfect consistency. The most important requirement for frothing milk is a milk temperature of 4–8 °C. We would therefore recommend using a milk cooler or a milk container.

- ▶ Remove the protective cover from the fine foam frother.
- ▶ Connect the milk pipe to the fine foam frother.

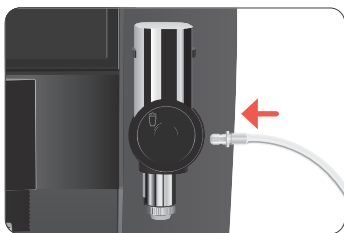

- i** The milk system of your J10 twin has a connector **HP3** and an interchangeable milk spout **CX3**.
- ▶ Connect the other end of the milk pipe to a milk container or a milk cooler.

4 Preparation

- i** If the screensaver is active, touch the display to return to the start screen.
- i** Coffee tastes best served hot. A cold porcelain cup cools the beverage – and impairs the taste. We therefore recommend prewarming the cups. You can purchase a JURA cup warmer from your specialised dealer.

Espresso and coffee

Example: Coffee





- ▶ Place a cup under the coffee spout.



- ▶ Tap **'Coffee'**.
The preset amount of water for coffee flows into the cup.

Preparation with preselection (Aroma Selection and Speciality Selection)

With the Aroma Selection function  on your J10 twin, you can change the **coffee strength** of any given product before preparing it. You can also choose which **bean container** is used to prepare a coffee and select additional settings:

Speciality Selection	Meaning
 Double product (for coffee and espresso)	The product is prepared with two brewing operations (two strokes).
 Cold Brew	The product is prepared using the Cold Extraction Process, which involves extraction with cold water pulsed at high pressure.
S Sweet Foam (all speciality coffees with milk)	Use the syrup attachment provided to prepare the product with sweet milk foam.
 Light Brew	The product is prepared using less ground coffee and at a reduced brewing temperature, making it easier to digest and ready to drink immediately.
 Ground coffee (all speciality coffees except for espresso doppio)	The product is prepared with ground coffee.

- i** Not all settings are available for all products.

Example: Cappuccino with higher coffee strength

- ▶ Place a cup under the fine foam frother.



- ▶ Touch the 'Aroma Selection' symbol  (bottom centre).
- ▶ Touch **'Cappuccino'** (within 10 seconds).
- ▶ Touch the setting control (circle) for the appropriate grinder to increase the coffee strength.

- i** You can also select which grinder should be used (100% / 50% / 0%).

- ▶ Touch **'Next'**.
'Easy Mode' appears. In this mode, you can configure additional settings.
- ▶ Touch the **image** of the cappuccino (or **'Start'**).
Preparation starts. The cappuccino is prepared according to your chosen settings.

Sweet latte (prepared with syrup attachment)

The Sweet Latte is a speciality coffee with sweet milk foam. To make this speciality, use the syrup attachment provided.

- i** All specialities with milk can also be prepared with **sweet milk foam**. To do this, use the syrup attachment provided and before starting preparation, select the Speciality Selection **S**.

Precondition: Milk is connected to the fine foam frother.

- ▶ Remove the cover from the syrup attachment.



- ▶ Fill the syrup attachment with syrup. Fill it to the first, second or third mark depending on the desired sweetness.
- ▶ Close the syrup attachment.
- ▶ Touch 'Sweet Latte'.
'Please remove the fine foam frother and connect the syrup attachment.'
- ▶ Remove the lower part of the fine foam frother.



- ▶ Connect the syrup attachment to the fine foam frother.



- ▶ Touch 'Next'.
- ▶ Turn the setting wheel of the fine foam frother to the 'Milk Foam' position.
- ▶ Place a cup under the fine foam frother.
- ▶ Touch 'Next'.
The preset amounts of coffee and milk foam flow into the cup.
'Please remove the syrup attachment for cleaning and connect the fine foam frother.'
- ▶ Remove the syrup attachment and rinse it thoroughly under running water.

i The syrup attachment, including the cover, is dishwasher-safe.

- ▶ Re-attach the lower part of the fine foam frother.
- ▶ Touch 'Next'.

i **8 minutes** after preparation, the milk system is **automatically** rinsed. Therefore always place a receptacle under the fine foam frother after preparing milk.

To ensure that the fine foam frother always works properly, you must clean it **daily** when you have been preparing milk (see chapter 7 'Maintenance – Cleaning the milk system').

Cold Brew

The 'Cold Brew' preselection ☼ is used to prepare a cold speciality coffee.

Example: Cold Brew coffee



- ▶ Fill the water tank with **cold** water.

i The temperature of the water in the water tank affects the brewing result. Use fresh, cold water.

4 Preparation

- Add ice cubes to a glass according to your own preferences.
- Place the glass under the coffee spout.



- Touch the 'Aroma Selection' symbol  (bottom centre).
- Touch 'Coffee'.
- Touch  to activate the 'Cold Brew' preselection.
- Touch 'Next'.
- Tap on the **image** of the coffee (or on 'Start').

i A **Cold Brew speciality coffee** can only be prepared using a **mild** grind consistency setting. If the grind consistency is set to 'INTENSE', you will be asked to change it to 'MILD' using the grinder adjustment switch.

The preset amount of water for the coffee flows into the glass.

Latte macchiato, cappuccino and other speciality coffees with milk

Your J10 twin prepares the following speciality coffees with milk at the touch of a button:

- Latte macchiato
- Cortado
- Cappuccino
- Caffè latte
- Flat white
- Macchiato

Example: Latte macchiato

Precondition: Milk is connected to the fine foam frother.

- Place a glass under the fine foam frother.



- Tap 'Latte macchiato'.
- The preset amounts of milk and milk foam flow into the glass.

i There is a short interval while the hot milk separates from the milk foam. This allows the typical layers of a latte macchiato to form.

The preset amount of water for espresso flows into the glass.

i **8 minutes** after preparation, the milk system is **automatically** rinsed. Therefore always place a receptacle under the fine foam frother after preparing milk.

To ensure that the fine foam frother always works properly, you must clean it **daily** when you have been preparing milk (see chapter 7 'Maintenance – Cleaning the milk system').

Milk and milk foam

Your J10 twin prepares hot milk and milk foam. To do this, turn the setting wheel of the fine foam frother to the 'Milk Foam' or 'Milk' position.

i **8 minutes** after preparation, the milk system is **automatically** rinsed. Therefore always place a receptacle under the fine foam frother after preparing milk.

Americano and lungo

For the americano and lungo, the J10 twin blends the coffee with hot water using a special preparation method. This results in a full-bodied speciality coffee which is particularly easy to digest. You can change the amount of this additional water (see chapter 4 'Preparation – Adjusting the product settings').

The americano must first be placed on the start screen: to do this, tap on any product for 2 seconds, then select the americano using the 'Replace product' function.

Espresso doppio

'Doppio' is Italian for 'double'. When you select Espresso doppio, two espressos are prepared one after the other. The result is an extra full-bodied and aromatic speciality coffee.

The espresso doppio must first be placed on the start screen. To do this, tap on any product for 2 seconds, then select the espresso doppio using the 'Replace product' function.

Ground coffee

You can choose to use a second coffee variety, for example decaffeinated coffee, with the filter funnel for ground coffee.

- Never add more than two level measuring spoons of ground coffee.
- Use ground coffee which is not ground too finely. Very fine coffee can block up the system so that the coffee only comes out in drips.
- If you did not fill the machine with a sufficient amount of ground coffee, 'Not enough ground coffee' is displayed and the J10 twin stops the operation.
- The desired speciality coffee must be prepared within approximately one minute after filling with the ground coffee. Otherwise the J10 twin stops the operation and is once more ready for use.

Example: Espresso with ground coffee

- ▶ Place an espresso cup under the coffee spout.
- ▶ Tap the 'Aroma Selection' symbol ☑ (bottom centre).
- ▶ Tap 'Espresso'.
- ▶ Tap ☑.
- ▶ Touch 'Next'.
- ▶ Touch 'Start'.
- ▶ 'Please add ground coffee'
- ▶ Open the powder chute cover.

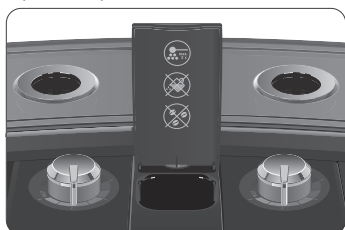

- ▶ Place the filler funnel on the powder chute.



- ▶ Add the desired amount of ground coffee to the filler funnel (max. 2 level measuring spoons).
- ▶ **i** The amount of ground coffee determines the intensity and aroma of the beverage, so you can adjust it to your personal preferences.
- ▶ Remove the filler funnel and close the cover of the powder chute.
- ▶ Touch 'Next'.
- ▶ The preset amount of water for espresso flows into the cup.
- ▶ **i** The powder chute and cover can be removed and also cleaned, if necessary.

4 Preparation

Hot water

The J10 twin allows you to prepare different variants of hot water:

- 'Hot water'
- 'Hot water for green tea' (Product must be added to the start screen. To do this, tap and hold any product for 2 seconds, then use the 'Replace product' function to select hot water for green tea.)

⚠ CAUTION

There is a danger of scalding from hot water splashes.

- Avoid direct contact with the skin.
-

Example: Hot water

- Place a cup under the hot-water spout.



- Tap 'Hot water'.
The preset amount of water flows into the cup.

Adjusting the grinder



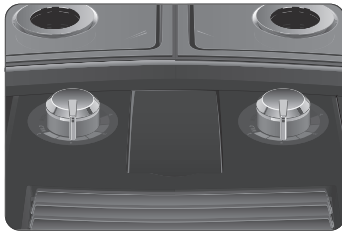

The grinder adjustment switches are used to adjust both grinders according to your preference for a mild or intense aroma.



- ⓘ A Cold Brew speciality coffee can only be prepared using a mild grind consistency setting. If the grind consistency is set to 'INTENSE', you will be asked to change it to 'MILD' using the grinder adjustment switch.

Adjusting the product settings



Tap and hold a product for **approximately 2 seconds** to access the settings:

- Save permanent settings for preferred coffee strength and quantity, change the product name or preselect options such as 'Sweet Foam' , 'Cold Brew' , 'Light Brew'  or 'Ground Coffee' .
- The 'Replace' symbol (bottom right) allows you to choose between 'Replace product' and 'Reposition the product'.

- ⓘ Depending on the selected product, different settings will be available which are represented by symbols on your display.

The settings always follow the same model.

Example: Change the **quantity** of one coffee

- Tap and hold 'Coffee' for **approx. 2 seconds**.
- Tap the symbol for fill volume .
- Tap < or > to change the setting.
- Tap  and confirm the setting with 'Yes'.

5 Daily operation

Switching the machine on and off

- Place one receptacle under the coffee spout and another under the fine foam frother.



- Press the On/Off button .

'Machine is rinsing'

Your J10 twin is switched on or off.

- i** When the machine is switched off, the system is only rinsed if a speciality coffee has been prepared.
- i** If milk has been prepared before switching off, you will be prompted to carry out milk system cleaning ('Clean the milk system'). After 30 seconds, the switch-off process continues automatically.

Filling the water tank

Daily maintenance of the machine and hygiene when handling coffee and water are key to a perfect coffee result in the cup every time. You should therefore change the water **daily**.

CAUTION

Milk, sparkling mineral water or other liquids can damage the water tank or the machine.



- Only fill the water tank with fresh, cold water.
- Remove the water tank and rinse it with cold water.
- Fill the water tank with fresh, cold water and reinsert the tank.

Maintenance actions

Optimal coffee quality depends on many factors. One important prerequisite is regular maintenance of your J10 twin. Carry out the following steps:

Maintenance action	Daily	If necessary	Note
Empty the drip tray and coffee grounds container and rinse with warm water (The insert for the drip tray, including the drip tray itself, and the coffee grounds container are dishwasher-safe)	▪		Always empty the coffee grounds container when the machine is switched on. This is the only way of resetting the coffee grounds counter.
Clean the milk system (if heavily soiled, also dismantle and rinse it)	▪		See chapter 7 'Maintenance – Cleaning the milk system'. We recommend that you dismantle and rinse the professional fine foam frother once a week (see chapter 7 'Maintenance – Dismantling and rinsing the professional fine foam frother')
Rinse the milk pipe	▪		
Rinse the water tank	▪		
Wipe the surface of the machine with a clean, soft, damp cloth (e.g. microfibre cloth)	▪		
Remove and clean the powder chute for ground coffee		▪	
Changing milk pipe with connector HP3		approx. every 3 months	
Change the interchangeable milk spout CX3		approx. every 3 months	
Clean the inside of the water tank with a brush		▪	
Clean the top and bottom of the cup grille		▪	

Maintenance action	Daily	If necessary	Note
Thoroughly clean the drip tray and coffee grounds container		▪	In the 'Maintenance' area  of the Cockpit, the message 'Maintenance information' appears.

- i** Perform a **self-diagnosis** on a regular basis to check the maintenance status of your J10 twin. To do this, tap on  in the Cockpit.
- i** You will find more information about the maintenance of your J10 twin in the 'Maintenance' area  in the programme item 'Maintenance information'.



6 Machine settings

Tap  on the start screen to open the JURA Cockpit. The following settings can be saved in 'Machine Settings' :

Programme item	Sub-item	Explanation
Page ● ○ ○		
'Choose language'		Set language
'Water hardness'		Set the hardness of the water used (1 °dH to 30 °dH) to prevent limescale building up in your machine
'Connections' (only displayed if JURA Wi-Fi Connect is being used)	'Connect to J.O.E.'	Wirelessly connect the J10 twin to the JURA app (J.O.E.®) or disconnect again
	'Connect to cooler'	Establish a wireless connection between your J10 twin and the Cool Control milk cooler or disconnect it again
Page ○ ● ○		
'Display'	'Set profile'	Create (0–4) profiles in the Cockpit and personalise 3 favourite speciality coffees for each
	'Product name'	Display product images with/without product names on the start screen
	'Grinder name'	Change the names of the grinders, e.g. to specify the beans that are used in each
	'Brightness'	Change display brightness (in 10% increments)
'Counter'	'Product counter'	View product counter
	'Maintenance counter'	View the maintenance counter
'General'	'Information'	View software version
	'Empty system'	Empty the system to protect the J10 twin from frost damage during transport
	'Factory setting'	Reset your J10 twin to factory settings (the machine then switches off)
Page ○ ○ ●		
'Timer'	'Switch off after'	To save energy, the switch-off time is set to 30 minutes ex-works. Possible settings: Switch-off after 15 minutes, 30 minutes or 1-9 hours after the last action on the machine If you extend the switch-off time, you therefore accept a high energy consumption. Energy consumption of the J10 twin when switched off: 0 Watt.
'Operating instructions'	'Coffee Eye'	Enable/disable operating instructions for 'Coffee Eye' automatic cup recognition
	'Aroma control'	Show recommended settings for consistency of grind (enabled/disabled)
	'Milk instructions'	Show instructions for using the syrup attachment and fine foam frother (e.g. switching between milk and milk foam)
	'Quality Assistant'	The Quality Assistant supports you with correct maintenance of your J10 twin
'Unit'		Set the unit for the amount of water (ml or oz)

7 Maintenance

Basic information about maintenance:

- You can manage the maintenance of your J10 twin in the **Cockpit** in the  section.
- If a maintenance programme needs to be initiated, the  area on the start screen appears with a red background. Touch  at the top to access the JURA Cockpit. In the Cockpit of your J10 twin, maintenance programmes that need to be carried out are shown in the form of messages with red backgrounds. Touch a message to go straight to the corresponding maintenance programme.
- Carry out each maintenance programme when you are prompted to do so.



Rinsing the machine

You can start coffee system rinsing manually at any time.

Precondition: The start screen is displayed.

- Place one receptacle under the coffee spout and another under the fine foam frother.



- Touch  at the top to access the JURA Cockpit.
- Touch the 'Maintenance' symbol .
- Tap 'Rinse' to start the rinsing process.
'Milk system is being rinsed'
'Machine is rinsing'
The rinse stops automatically.

Automatic milk system rinsing

8 minutes after preparation, the milk system is **automatically** rinsed. Therefore always place a receptacle under the fine foam frother after preparing milk.

Cleaning the milk system



Tap, click or scan to watch
the video tutorial on YouTube





To ensure that the milk system always works properly, you must clean it **daily** when you have been preparing milk.

CAUTION

If the wrong cleaning agent is used, the machine could be damaged and/or traces could be left behind in the water.

- Use only original JURA maintenance products.

-  JURA milk system cleaner is available from specialised dealers.
-  Use the container supplied for milk system cleaning.

Precondition: 'Clean the milk system' is displayed in the Cockpit.

- Touch  at the top to access the JURA Cockpit.
- Touch 'Clean the milk system'.
- Touch 'Next'.
'Cleaning agent for milk system' / 'Connect the milk tube' / 'Milk Foam position' / 'Attach the spout to the container'
- Remove the milk pipe from the milk container or milk cooler.

7 Maintenance

- ▶ Pour one dosing unit of milk system cleaner into the container for milk system cleaning.

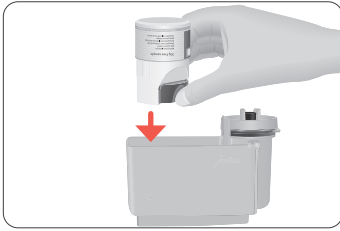

- ▶ Place the container under the coffee spout and the fine foam frother.
- ▶ Push the fine foam frother down as far as it will go to connect it firmly to the container.



- ▶ Connect the milk pipe to the container.

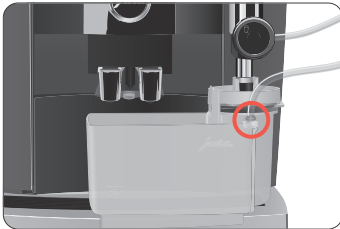

- i** To connect the milk pipe to the container correctly, the pipe must be fitted with a connector HP3.
- ▶ Turn the setting wheel of the fine foam frother to the 'Milk Foam' position.
- ▶ Touch 'Start'.
The fine foam frother and the milk pipe are cleaned.
The operation stops automatically.

Dismantling and rinsing the professional fine foam frother

If insufficient foam is produced when the milk is frothed or milk sprays out of the professional fine foam frother, the frother may be dirty. If this happens, dismantle and rinse the professional fine foam frother.

- i** We recommend that you dismantle and rinse the professional fine foam frother once a week.
- ▶ Remove the milk pipe and rinse it thoroughly under running water.
- ▶ Remove the professional fine foam frother.



- ▶ Dismantle the fine foam frother into its individual parts.

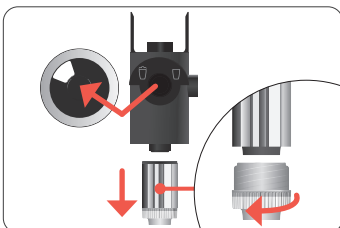

- ▶ Rinse all the parts under running water. If there are severely dried-on milk residues, firstly immerse the individual parts in a solution of 250 ml water and one dosing unit of JURA milk system cleaner. Then rinse the individual parts thoroughly.

- Re-assemble the professional fine foam frother.

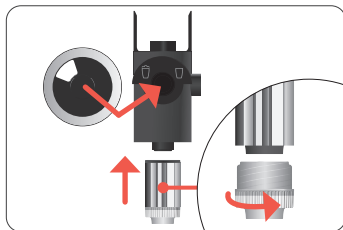

- ⓘ Ensure that all individual parts are correctly and firmly connected to ensure optimum operation of the professional fine foam frother.
- Re-fit the professional fine foam frother on the milk system.



Inserting/changing the filter

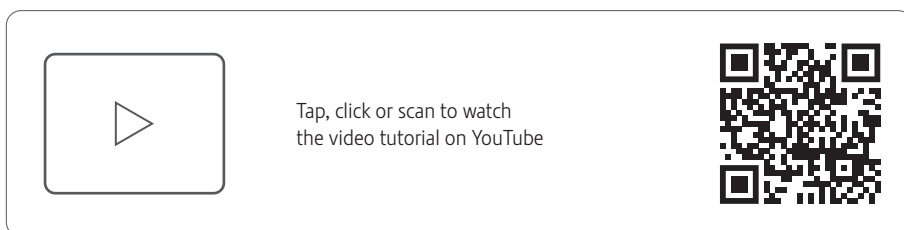

Once the filter cartridge stops working (depending on the water hardness setting), the J10 twin will prompt you to change the filter.

- ⓘ Your J10 twin no longer has to be descaled if you are using the CLARIS Smart+ filter cartridge.
 - ⓘ CLARIS Smart+ filter cartridges are available from specialised dealers.

Precondition: The start screen is displayed. (Alternatively 'Change the filter' is displayed in the Cockpit if the filter's capacity has been exhausted.)

- Remove and empty the water tank.
- Turn the filter casing anti-clockwise and remove it from the water tank.
- Open the filter casing.

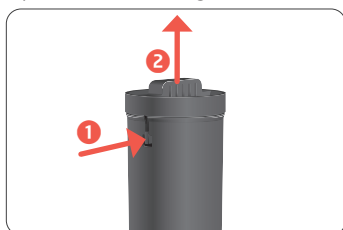

- Remove the used filter cartridge.
- Insert a **new** CLARIS filter cartridge Smart+.

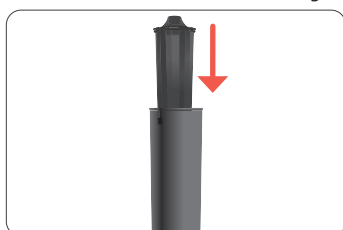

- Close the filter casing.
- Insert the filter casing into the water tank.

7 Maintenance

- ▶ Turn the filter casing clockwise until it audibly clicks into place.

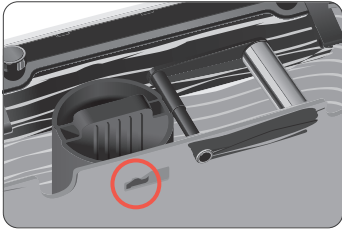

- ▶ Fill the water tank with fresh, cold water and reinsert the tank.
The machine automatically detects that you have just inserted/changed the filter cartridge.
'Filter is being rinsed', water flows directly into the drip tray.
'Empty drip tray'
- ▶ Empty the drip tray and coffee grounds container and put them back into the machine.
The start screen is displayed.

Cleaning the machine

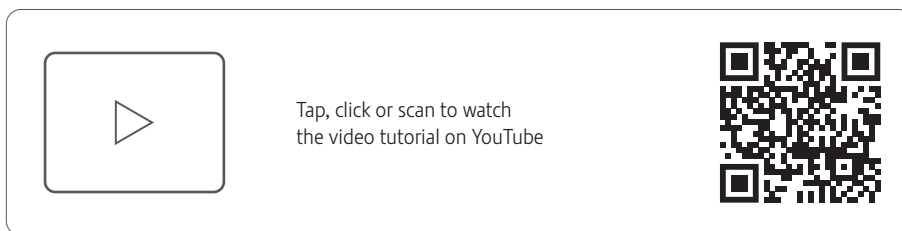

After 180 preparations or 80 switch-on rinses, the J10 twin will prompt you to clean it.

CAUTION

If the wrong cleaning agent is used, the machine could be damaged and/or traces could be left behind in the water.

- ▶ Use only original JURA maintenance products.

- i** The cleaning programme lasts approximately 20 minutes.
- i** JURA cleaning tablets are available from specialised dealers.

Precondition: 'Clean' is displayed in the Cockpit.

- ▶ Fill the water tank.
- ▶ Touch  at the top to access the JURA Cockpit.
- ▶ Touch 'Clean'.
- ▶ Touch 'Start'.
- ▶ 'Empty coffee grounds container' / 'Empty drip tray'
- ▶ Empty the drip tray and coffee grounds container and put them back into the machine.
- ▶ Place one receptacle under the coffee spout and another under the fine foam frother.



- ▶ Touch 'Next'.
- ▶ 'Machine is being cleaned'
- ▶ The operation is interrupted, 'Add cleaning tablet'.
- ▶ Open the powder chute cover.

- ▶ Insert a JURA cleaning tablet into the powder chute.

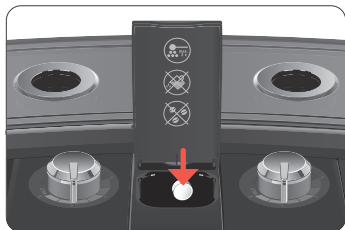

- ▶ Close the cover.
- ▶ Touch 'Next'.
'Machine is being cleaned'
'Empty coffee grounds container' / 'Empty drip tray'
- ▶ Empty the drip tray and coffee grounds container and put them back into the machine.

Descaling the machine

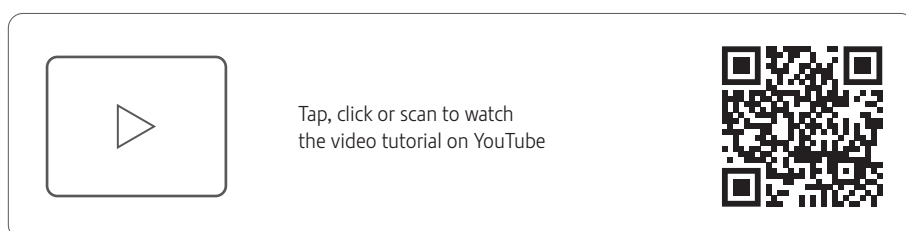

The J10 twin builds up deposits of limescale over time and automatically prompts you to descale it when necessary. The degree of calcification depends on the hardness of your water.

- i** If you are using a CLARIS Smart+ filter cartridge, you will not be prompted to descale.

⚠ CAUTION

If the descaling agent comes into contact with the skin or eyes, this can cause irritation.

- ▶ Avoid contact with the skin or eyes.
- ▶ Rinse off the descaling agent with clean water. Should you get any descaling agent in your eye, see a doctor.

CAUTION

If the wrong descaling agent is used, the machine could be damaged and/or traces could be left behind in the water.

- ▶ Use only original JURA maintenance products.

CAUTION

If the descaling operation is interrupted, there may be damage to the machine.

- ▶ Allow the descaling programme to run to the end.

CAUTION

If the descaling agent comes into contact with sensitive surfaces (e.g. marble), damage cannot be ruled out.

- ▶ Clean up any splashes immediately.

- i** The descaling programme lasts approximately 20 minutes.
- i** JURA descaling tablets are available from specialised dealers.

Precondition: 'Descal' is displayed in the Cockpit.

- ▶ Touch  at the top to access the JURA Cockpit.
- ▶ Touch 'Descal'.
- ▶ Touch 'Start'.
'Empty drip tray'
- ▶ Empty the drip tray and coffee grounds container and put them back into the machine.
'Pour descaling agent into water tank' / '500 ml'
- ▶ Remove the water tank and fill it with water up to the **DESCALE** mark.
- ▶ Completely dissolve 3 JURA descaling tablets in the water tank. This may take a few minutes.
- ▶ Reinsert the water tank.

7 Maintenance

- ▶ Place one receptacle under the hot-water spout and another under the fine foam frother.



- ▶ Touch 'Next'.
'Machine is being descaled', water flows repeatedly out of the hot-water spout and fine foam frother straight into the drip tray.
'Empty drip tray'
- ▶ Empty the drip tray and coffee grounds container and put them back into the machine.
'Rinse the water tank' / 'Fill water tank'
- ▶ Empty the receptacles and place them back under the hot-water spout and the fine foam frother.



- ▶ Remove the water tank and rinse it thoroughly.
- ▶ Fill the water tank with fresh, cold water and reinsert the tank.
- ▶ Touch 'Next'.
'Machine is being descaled', water flows repeatedly out of the hot-water spout and fine foam frother straight into the drip tray.
'Empty drip tray'
- ▶ Empty the drip tray and coffee grounds container and put them back into the machine.

i If the descaling operation stops unexpectedly, rinse the water tank thoroughly.

Descaling the water tank

Limescale deposits may form in the water tank. To ensure correct function of the machine, descale the water tank from time to time.

- ▶ Remove the water tank.
- ▶ If you use a CLARIS Smart+ filter cartridge, remove this.
- ▶ Completely fill the water tank and dissolve 3 JURA descaling tablets in it.
- ▶ Leave the water tank with the descaling solution for several hours (e.g. overnight).
- ▶ Empty the water tank and rinse it thoroughly.
- ▶ If you use a CLARIS Smart+ filter cartridge, insert this again.
- ▶ Fill the water tank with fresh, cold water and reinsert the tank.

Cleaning the bean container

Coffee beans may be covered with a slight oil film which remains on the walls of the bean container. These traces may negatively affect the coffee result. For this reason clean the bean container from time to time.

Precondition: 'Fill bean container' is displayed.

- ▶ Switch the machine off with the On/Off button .
- ▶ Remove the aroma preservation cover.
- ▶ Clean the bean container with a soft, dry cloth.
- ▶ Fill the bean container with coffee beans and close the aroma preservation cover.

8 Display messages

Messages on the start screen

Message	Cause/Result	Action
'Fill water tank'	The water tank is empty. You cannot prepare any products.	▶ Fill the water tank (see chapter 5 'Daily operation – Filling the water tank').
'Empty coffee grounds container' / 'Empty drip tray'	The coffee grounds container is full. / The drip tray is full. You cannot prepare any products.	▶ Empty the coffee grounds container and the drip tray (see chapter 5 'Daily operation – Maintenance actions').
'Drip tray not fitted'	The drip tray is not inserted correctly or is not inserted at all. You cannot prepare any products.	▶ Fit the drip tray.
'Fill left bean container' / 'Fill right bean container'	One of the bean containers is empty. You cannot prepare any speciality coffees for which coffee beans are required from this bean container. You can prepare hot water or milk.	▶ Fill the bean container (see chapter 3 'Preparing and using for the first time – Filling the bean container').
'Not enough ground coffee'	There is insufficient ground coffee in the machine; the J10 twin stops the operation.	▶ The next time you prepare a beverage, add more ground coffee (see chapter 4 'Preparation – Ground coffee').

Messages in the Cockpit

Message	Cause/Result	Action
The filter symbol  lights up red. 'Change the filter'	The filter cartridge is used up.	▶ Replace the CLARIS Smart+ filter cartridge (see chapter 7 'Maintenance – Inserting/changing the filter').
'Clean'	The J10 twin is prompting you to clean it.	▶ Perform cleaning (see chapter 7 'Maintenance – Cleaning the machine').
'Descale'	The J10 twin is prompting you to descale it.	▶ Perform descaling (see chapter 7 'Maintenance – Descaling the machine').
'Clean the milk system'	The J10 twin prompts you to clean the milk system.	▶ Perform milk system cleaning (see chapter 7 'Maintenance – Cleaning the milk system').

9 Troubleshooting

Problem	Cause/Result	Action
Insufficient foam is produced when the milk is frothed or milk sprays out of the fine foam frother.	The fine foam frother is dirty.	▶ Clean the fine foam frother (see chapter 7 'Maintenance – Cleaning the milk system'). ▶ Dismantle and rinse the fine foam frother (see chapter 7 'Maintenance – Dismantling and rinsing the professional fine foam frother').
The 'Coffee Eye' reports a cup under the coffee spout even though no cup has been placed there.	The cup detection sensor behind the coffee spout is dirty.	▶ Clean the sensor with a damp cloth.
Coffee only comes out in drips when it is being prepared.	The coffee is ground too finely and obstructs the system.	▶ Choose a coarser grinder setting or use coarser ground coffee.
	The water hardness may not have been correctly set.	▶ Perform descaling (see chapter 7 'Maintenance – Descaling the machine').
There is dry ground coffee behind the coffee grounds container.	The beans used are resulting in an above-average volume of ground coffee.	▶ Reduce the coffee strength or choose a finer grinder setting (see chapter 4 'Preparation – Adjusting the product settings').
'Fill water tank' is not displayed although the water tank is empty.	There is a lot of limescale in the water tank.	▶ Descale the water tank (see chapter 7 'Maintenance – Descaling the water tank').
Grinder is making a very loud noise.	There are foreign objects in the grinder.	▶ Contact customer support in your country (see chapter '13 JURA contact details / Legal information').
'ERROR 2' or 'ERROR 5' is displayed.	If the machine has been exposed to the cold for a long period of time, heating may be disabled for safety reasons.	▶ Warm the machine at room temperature.

Problem	Cause/Result	Action
Other 'ERROR' messages are displayed.	–	<ul style="list-style-type: none"> ▸ Switch the J10 twin off with the On/Off button ϕ. Contact customer support in your country (see chapter '13 JURA contact details / Legal information').

i If you were unable to solve the problem, contact customer support in your country (see chapter '13 JURA contact details / Legal information').

10 Transport and environmentally friendly disposal

Transport / Emptying the system

Keep the packaging for your J10 twin. It should be used to protect the machine during transport.

In order to protect the J10 twin from frost during transport, the system must be emptied.

Precondition: The start screen is displayed.

- Remove the milk pipe from the fine foam frother.
- Place one receptacle under the hot-water spout and another under the fine foam frother.



- Touch \equiv at the top to access the JURA Cockpit.
 - Touch the 'Machine setting' \otimes symbol.
 - Tap \gt to call up page $\circ \bullet \circ$.
 - Tap 'General'.
 - Tap 'Empty system'.
 - Touch 'Next'.
 - 'Remove the water tank'
 - Remove and empty the water tank.
 - Touch 'Start'.
- Steam will continue to be discharged from the fine foam frother and the hot-water spout until the system is empty.
Your J10 twin is switched off.

Disposal

Please dispose of old machines in an environmentally neutral way.



Old machines contain valuable, recyclable materials which should be recycled. Please therefore dispose of old machines via suitable collection systems.

11 Technical data

Voltage	220–240 V ~, 50 Hz
Power	1450 W
Conformity mark	CE UK
Pump pressure	static max. 15 bar
Holding capacity of water tank (without filter)	1.9 l
Holding capacity of bean container	2 × 180 g
Holding capacity of coffee grounds container	max. 16 servings
Cable length	approx. 1.1 m
Weight	11.8 kg
Dimensions (W × H × D)	31 × 36.1 × 44.6 cm
Milk system with connector	HP3
Interchangeable milk spout	CX3

CLARIS Smart+ filter cartridge (RFID technology)	Frequency band 13.56 MHz Max. transmission power < 1 mW
JURA Wi-Fi Connect (Wi-Fi connection)	Frequency band 2.4 GHz Max. transmission power < 100 mW
JURA type	785

Information for testers (repeat test in accordance with DIN VDE 0701-0702): The central grounding point (CGP) is located on the back of the machine, right next to the mains cable's connection point.

12 Index

A

- Addresses 26
- Adjusting the product settings 14
- Americano 13
- Aroma preservation cover
 - Bean container with aroma preservation cover 3
- Aroma Selection 10

B

- Bean container
 - Bean container with aroma preservation cover 3
 - Cleaning 22
 - Filling 6
- Bus bar
 - Technical data 24
- Button
 - On/Off button 3

C

- Caffè latte 12
- Cappuccino 12
- Central grounding point 25
- Children 4
- CLARIS Smart filter cartridge
 - Changing 19
 - Inserting 19
- Cleaning
 - Bean container 22
 - Machine 20
- Cockpit 8, 16
- Coffee 10
- Coffee grounds container 3
- Coffee spout 3
- Cold Brew 11
- Consistency of grind
 - Adjusting the grinder 14
 - Grinder adjustment switch 3
- Contact details 26
- Cup grille 3
- Customer support 26

D

- Damage
 - Preventing damage 5
 - What to do in the event of damage 4
- Declaration of Conformity 26
- Descaling
 - Machine 21
 - Water tank 22
- Display
 - Cockpit 8
 - Touch display 3
- Display messages 23
- Disposal 24
- Drip tray 3
 - Insert 3

E

- Emptying the system 24
- Errors
 - Troubleshooting 23

- Espresso 10
- Espresso doppio 13
- EU Declaration of Conformity 26

F

- Filler funnel
 - Filler funnel for ground coffee 3
- Filling
 - Bean container 6
 - Water tank 15
- Filter
 - Changing 19
 - Inserting 19
- Filter casing 3
- Fine foam frother
 - Professional fine foam frother 3
- First-time use 6
- Flat white 12

G

- Grinder adjustment switch 3
- Ground coffee 13
 - Measuring spoon for ground coffee 3
 - Powder chute for ground coffee 3
- Grounding point 25

H

- Hotline 26
- Hot water 14
- Hot-water spout 3

I

- Insert for drip tray 3
- Instant coffee
 - Ground coffee 13
- Interchangeable milk spout 25

J

- JURA
 - Contact details 26

L

- Latte macchiato 12
- Lungo 13

M

- Macchiato 12
- Machine
 - Cleaning 20
 - Descaling 21
 - Rinsing 17
 - Setting up 6
- Machine settings 16
- Mains cable 3
- Maintenance 17
- Maintenance actions 15
- Measuring spoon for ground coffee 3
- Messages, display 23
- Milk 12
 - Connecting milk 8
- Milk foam 12

13 JURA contact details / Legal information

- Milk system 25
 - Clean 17
 - Professional fine foam frother 3
 - Syrup attachment 3, 11
- Milk system rinsing 17

P

- Powder chute
 - Powder chute for ground coffee 3
- Preparation 9, 12
 - Americano 13
 - Aroma Selection 10
 - Caffè latte 12
 - Cappuccino 12
 - Coffee 10
 - Cold Brew 11
 - Espresso 10
 - Espresso doppio 13
 - Flat white 12
 - Ground coffee 13
 - Hot water 14
 - Latte macchiato 12
 - Lungo 13
 - Macchiato 12
 - Milk 12
 - Milk foam 12
 - Speciality Selection 10
 - Sweet latte 11
- Problems
 - Troubleshooting 23
- Product settings
 - Adjusting 14
- Professional fine foam frother 3
 - Dismantling and rinsing 18
- Proper use 4

R

- RFID 25
- Rinsing
 - Machine 17

S

- Safety information 4
- Service socket 3
- Setting up
 - Setting up the machine 6
- Speciality Selection 10
- Spout
 - Hot-water spout 3
- Sweet latte 11
- Switching off 15
- Switching on 15
- Symbol description 4
- Syrup attachment 3, 11

T

- Tank
 - Water tank 3
- Technical data 24
 - Interchangeable milk spout 25
 - Milk system 25
- Tel 26
- Touch display 3
- Transport 24
- Troubleshooting 23

U

- Use, First-time 6
- Users 4

W

- Water hardness
 - Determining the water hardness 6
- Water tank 3
 - Descaling 22
 - Filling 15
- Wi-Fi 25
- Wi-Fi Connect 3, 9
- Wi-Fi connection 9
- Wireless connection 9, 19, 25

13 JURA contact details / Legal information

JURA Elektroapparate AG
Kaffeeweltstrasse 10
CH-4626 Niederbuchsiten
Tel. +41 (0)62 38 98 233

- i** You can find additional contact details for your country at jura.com.
- i** If you need assistance with using your machine, you can find this at jura.com/service.
- i** Your opinion is important to us! Use the contact details at jura.com.

Directives

The machine complies with the following directives:

- 2014/35/EU – Low Voltage Directive
- 2014/30/EU – Electromagnetic Compatibility
- 2009/125/EC – Ecodesign Directive
- 2011/65/EU – RoHS Directive
- 2014/53/EU – Wireless Voltage Directive

A detailed EU Declaration of Conformity for your J10 twin can be found at jura.com/conformity.

Technical changes

We reserve the right to make technical changes. The diagrams used in these instructions for use are for illustration purposes only and do not represent the original colours of the machine. Some details of your J10 twin may vary.