



Z10 (EB/SB/INTB)

Instructions for Use



Additional online content

Tap, click or scan the QR code to access additional online resources.

There are video tutorials to help you operate your Z10.





jura.com/support-Z10B

Your Z10

1	Control elements	3
2	For your safety	4
	Comply with the instructions for use	4
	Proper use	4
	User limitations	4
	Use by children	4
	What to do in the event of damage	4
	Preventing damage	5
	Danger of electric shock	5
	Danger of burns, scalding and injury	5
3	Preparing and using for the first time	6
	Setting up the machine	6
	Filling the bean container	6
	Determining the water hardness	6
	First-time use	6
	Managing your Z10 – the JURA Cockpit	8
	Connecting milk	8
	Connect the machine with J.O.E.® - your JURA app	9
	Coffee Timer	9
4	Preparation	10
	Worlds of indulgence of your Z10	10
	Easy Mode – one-off settings before preparation	11
	Espresso and coffee	11
	Flat white ('Sweet Foam' world of indulgence)	11
	Coffee ('Cold Brew' world of indulgence)	12
	Chocolate foam and mocaccino	12
	Latte macchiato, cappuccino and other speciality coffees with milk	13
	Americano and special coffee	14
	Espresso doppio	14
	Pot of coffee	14
	Ground coffee	14
	Hot water	15
	Adjusting the product settings	15
5	Daily operation	16
	Switching the machine on and off	16
	Filling the water tank	16
	Maintenance actions	16
6	Machine settings	17
7	Maintenance	18
	Cleaning the milk system	18
	Dismantling and rinsing the dual spout	18
	Inserting/changing the filter	20
	Cleaning the machine	20
	Descaling the machine	20
	Descaling the water tank	21
	Cleaning the bean container	21
8	Display messages	21
9	Troubleshooting	22
10	Transport and environmentally friendly disposal	23
	Transport / Emptying the system	23
	Disposal	23
11	Technical data	23
12	Index	24
13	JURA contact details / Legal information	25

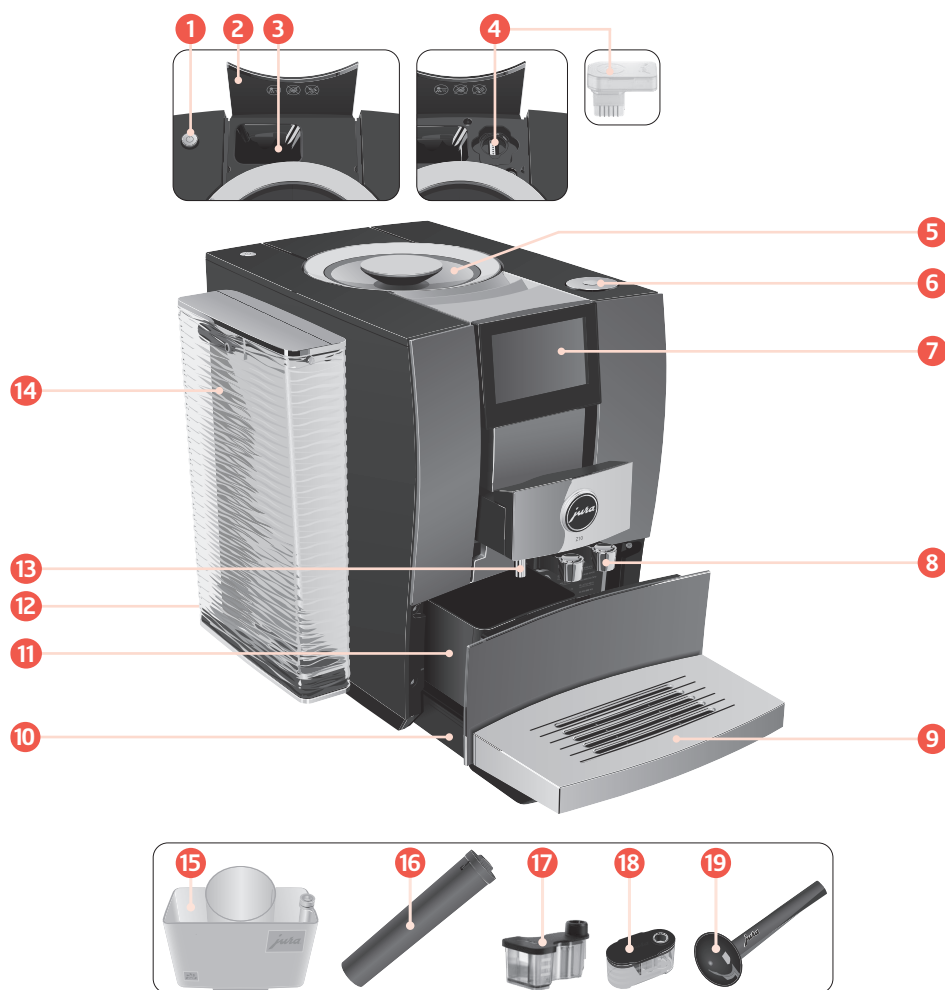
1 Control elements





- 1 On/Off button 
- 2 Cover for powder chute for ground coffee
- 3 Powder chute for ground coffee
- 4 Service socket with JURA Wi-Fi Connect (under cover)
- 5 Bean container with aroma preservation cover
- 6 Rotary Switch
- 7 Touch display
- 8 Height- and width-adjustable dual spout
- 9 Cup grille
- 10 Drip tray
- 11 Coffee grounds container
- 12 Mains cable (permanently connected or plug-in)
- 13 Hot-water spout
- 14 Water tank
- 15 Container for milk system cleaning
- 16 Filter casing
- 17 Chocolate attachment
- 18 Syrup attachment
- 19 Measuring spoon for ground coffee

2 For your safety

Comply with the instructions for use

Before using the machine, read these instructions for use thoroughly and completely and comply with the instructions they contain. Keep these instructions for use close to the machine and pass them on to the next user.

Failure to observe the instructions for use may result in serious injuries or damage to property. Safety information is therefore indicated as follows:

 WARNING	Indicates circumstances that may result in serious injuries or death.
 CAUTION	Indicates circumstances that may result in minor injuries.
CAUTION	Indicates circumstances that may result in damage to property.

Proper use

The machine is intended for private domestic use. It should only be used for coffee preparation and to heat milk and water. Use for any other purpose will be deemed improper.

User limitations

People, including children, who

- do not have the physical, sensory or mental capabilities to use the machine safely or
- are inexperienced or lack knowledge

must be supervised by a responsible person when using it, or must be instructed in how to use it correctly.

When using the CLARIS Smart+ filter cartridge or a JURA Wi-Fi Connect, wireless connections are established. Specific details on the frequency band used and the maximum transmission power can be found in the '11 Technical data' section.

Use by children

Children must be able to recognise and understand the potential dangers arising from incorrect use:

- Keep **children under the age of 8** away from the machine, or supervise them constantly.
- **Children aged 8 and over** may only operate the machine without supervision if they have been instructed in how to use it safely.
- Children may not clean or service the machine unless supervised by a responsible person.
- Do not allow children to play with the machine.

What to do in the event of damage

Never use a damaged machine or mains cable. This could result in fatal electric shock.

- In the event of signs of damage, disconnect the machine from the mains. To do this, first switch the Z10 off with the On/Off button . Only then should you remove the mains plug from the power socket.
- Replace a damaged **plug-in mains cable** with an original JURA mains cable. Unsuitable mains cables may result in consequential damage.
- Only permit authorised JURA service centres to carry out **repairs to the machine** and the **permanently connected mains cable**. Unsuitable repairs may result in consequential damage.

Preventing damage

To avoid damage to the machine and the mains cable:

- The Z10 must not be placed in a cabinet when in use.
- Do not use the Z10 and the mains cable near hot surfaces.
- Do not allow the mains cable to rub against sharp edges and ensure that it does not become trapped.
- Never allow the mains cable to loosely hang down. The mains cable could pose a tripping hazard or become damaged.
- Protect the Z10 from weather and direct sunlight.
- Only connect the Z10 to a mains voltage corresponding to that stated on the rating plate. The rating plate is located on the underside.
- Connect the Z10 directly to a domestic power socket. Using multi-socket adapters or extension cords may cause overheating.
- The surface of the heating element and outer enclosure remains hot after use and the outside of the appliance may retain heat.
- Do not use alkaline or alcohol-based cleaning agents; only use mild cleaning agents and a soft cloth.
- Do not use any coffee beans treated with additives or caramelised coffee beans.
- Only fill the water tank with fresh, cold, non-carbonated water.
- Switch the machine off with the On/Off button  if you are going to be absent for a longer period of time and remove the mains plug from the power socket.
- Only use original JURA maintenance products. Use of products that are not explicitly recommended by JURA could damage your Z10.

Danger of electric shock

Water conducts electricity. Do not bring water and electricity into contact with one another:

- Never touch the mains plug with wet hands.
- Do not immerse the Z10 and/or mains cable in water.
- Do not put the Z10 or any individual parts in the dishwasher.
- Before cleaning, switch the Z10 off with the On/Off button . Always wipe the Z10 with a damp cloth rather than a wet one, and protect it from prolonged exposure to water splash. The Z10 must not be cleaned with a jet of water.
- The Z10 is not suitable for installation on a surface where a jet of water can be used.

Danger of burns, scalding and injury

- Do not touch the spouts during operation. Use the handles provided.
- Optionally, your Z10 can be remotely operated using mobile devices. When preparing a product or initiating a maintenance programme, make sure that other people are not put at risk – for example, through contact with the spouts.
- Be careful to ensure that the dual spout is correctly installed and clean. Otherwise parts may come loose. There is a danger of parts being swallowed.

'Water hardness'

i Please refer to the section above for a description of how to determine the water hardness.

- ▶ Touch < or > to change the water hardness setting.
- ▶ Touch 'Save'.

'Saved' appears briefly on the display.

'Insert filter'

- ▶ Place a receptacle under the dual spout.



- ▶ Remove the water tank and rinse it with cold water.
- ▶ Open the filter casing.

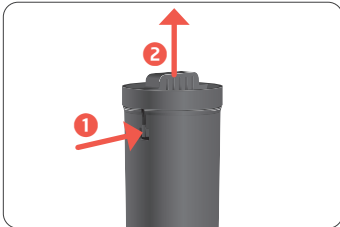

- ▶ Insert the CLARIS Smart+ filter cartridge.

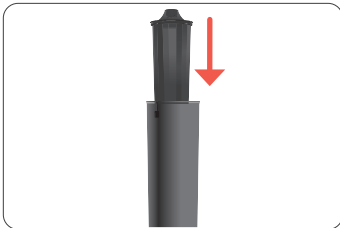

- ▶ Close the filter casing.
- ▶ Insert the filter casing into the water tank.
- ▶ Turn the filter casing clockwise until it audibly clicks into place.

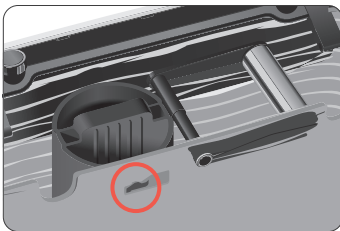

- ▶ Fill the water tank with fresh, cold water and reinsert the tank.

i The machine automatically detects that you have just inserted the filter cartridge.

'Filter is being rinsed', water flows directly into the drip tray.

'System is filling', water flows out of the hot-water spout.

'Empty drip tray'

- ▶ Empty the drip tray and put it back into the machine. Empty the receptacle and place it under the dual spout again.



3 Preparing and using for the first time

'Connect to milk cooler'

i You have the option of connecting the Z10 to the JURA Cool Control milk cooler (wireless connection). To do this, touch 'Connect' and follow the instructions on the display.

▶ Touch 'Next'.

'Connect to J.O.E.'

i If you would like to connect the Z10 to your home network, touch 'Connect' and follow the instructions on the display. You can also establish the connection later on (in the machine settings under 'Connect to J.O.E.').

▶ Touch 'Next'.

'Support'

i Scan the QR code to view our website. If you can't find the information you're looking for in this printed manual, you'll find the answer in our detailed online instructions for use. Support videos show you the necessary maintenance procedures.

▶ Touch 'Next'.

'Machine is rinsing' / 'Milk system is being rinsed', water flows out of the dual spout.

'Choose your world'

i Now select one of the **worlds of indulgence** of your Z10.





i If no selection is made, 'Classic Hot Brew' is set automatically after 10 seconds. You can change this selection at any time.

The start screen is displayed. Your Z10 is ready for use.

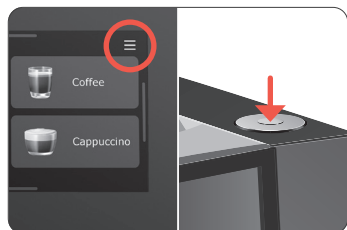
Managing your Z10 – the JURA Cockpit

The **JURA Cockpit** allows you to manage your Z10. Tap  at the top right or press the Rotary Switch to access the Cockpit.



Symbol	Meaning
	'Machine settings' area (green)
	'Maintenance' area (blue)
	Filter mode
 (white)	Your Z10 is connected to the network and/or Cool Control via JURA Wi-Fi Connect
 (red)	No connection to the Wi-Fi network

Connecting milk

Your Z10 creates fine, creamy, feather-light milk foam with a perfect consistency. The most important requirement for frothing milk is a milk temperature of 4–8 °C. We would therefore recommend using a milk cooler or a milk container.

▶ Connect the milk pipe to the dual spout.

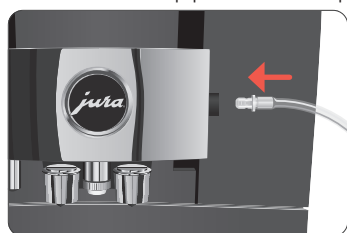

i The milk system of your Z10 has a connector **HP3** and an interchangeable milk spout **CX3**.

▶ Connect the other end of the milk pipe to a milk container or a milk cooler.

i After you have prepared a product with milk, the Milk Assistant will prompt you to rinse the milk system. Ideal if you use both milk and milk alternatives.

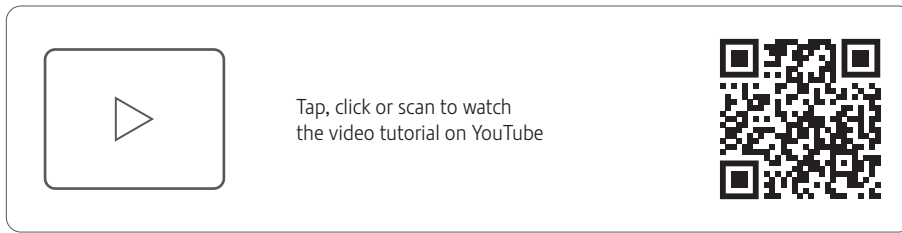

Connect the machine with J.O.E.® - your JURA app



Your Z10 can be connected with J.O.E.®, your JURA app.



Precondition: J.O.E.® is installed on your mobile device. The JURA Wi-Fi Connect is inserted into the service socket of your Z10.

- Tap  at the top right or press the Rotary Switch to access the JURA Cockpit.
- Tap the 'Machine settings' symbol .
- Tap '1/2' at the top right or swipe from right to left across the display to open the second page of the settings.
- Tap 'Connect to J.O.E.'.
- Press the 'Connect' button and follow the instructions on the display and in J.O.E.®.

Coffee Timer

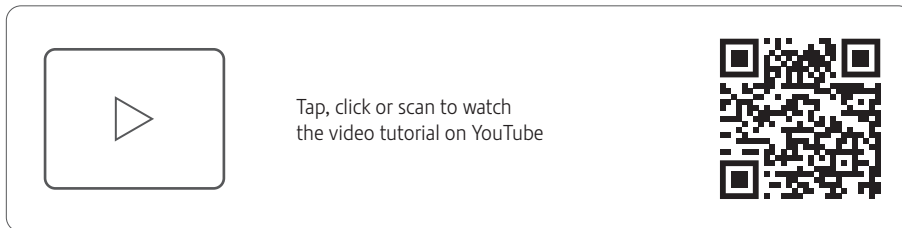

In conjunction with the JURA app J.O.E.®, the Coffee Timer offers your favourite coffee at the right time. Preparation can be programmed up to 16 hours in advance.

Please observe the following instructions when using the Coffee Timer:

- The Z10 starts preparation **automatically** at the time you have set. Make sure that there are no people or pets in the immediate vicinity of the spouts at this time. There is a risk of scalding.
- Make sure that the Z10 is properly prepared (water tank and bean container filled) and that all parts are correctly assembled.
- Place the glass or cup under the correct spout.
- Preparing a speciality coffee with **milk**:
 - Make sure that the milk pipe is connected correctly.
 - Use a milk cooler (e.g. the JURA Cool Control) and check whether there is enough milk in the milk cooler.
 - Do not leave milk in an unrefrigerated container for a long period of time. Unrefrigerated milk can spoil quickly.

4 Preparation

Tap ●○○○○ or swipe from right to left across the display to show other pages of the start screen.

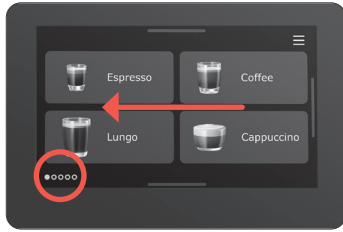

Specialities:

Page ●○○○○	
'Espresso'	'Coffee'
'Lungo'	'Cappuccino'
Page ○●○○○	
'Cortado'	'Flat White'
'Long Black'	'Latte macchiato'
Page ○○●○○	
'Mocaccino'	'Espresso Macchiato'
'Americano'	'Chocolate foam'
Page ○○○●○	
'Caffè latte'	'Espresso doppio'
'Milk foam'	'Milk'
Page ○○○○●	
'Hot water'	'Hot water for green tea'
'Pot of coffee'	
Turn the Rotary Switch to view the product selector.	

Basic information about preparing drinks:

Aim	What to do
Change the amount, coffee strength and temperature for any given product permanently	once: Touch and hold the image of a product for 2 seconds and apply the desired settings for the next preparation in 'Easy Mode' (start preparation by tapping the product image) permanently: Touch and hold the image of a product for 2 seconds, then go to ⚙️ in the top right-hand corner and apply the desired settings in 'Product settings'
Preparing products with ground coffee	Touch and hold the image of a product for 2 seconds and in 'Easy Mode' make the preselection ☕
Prepare two speciality coffees (for espresso, coffee, americano, special coffee and Long Black)	Touch and hold the image of a product for 2 seconds and in 'Easy Mode' make the preselection ☕

i Coffee tastes best served hot. A cold porcelain cup cools the beverage – and impairs the taste. We therefore recommend prewarming the cups. You can purchase a JURA cup warmer from your specialised dealer.

Worlds of indulgence of your Z10

Choose between four worlds of indulgence to prepare the specialities offered by your Z10. Swipe your finger from bottom to top across the start screen to access the selection of the worlds of indulgence:

- **☕** 'Classic Hot Brew'
 - The product is prepared hot using the classic brewing method.
- **☕** 'Light Brew'
 - The product is prepared using less ground coffee and at a reduced brewing temperature, making it easier to digest and ready to drink immediately.
- **S** 'Sweet Foam'
 - The product is prepared with sweet milk foam. Use the syrup attachment supplied for this.
- **❄️** 'Cold Brew'
 - The product is prepared using the Cold Extraction Process, which involves extraction with cold water pulsed at high pressure.

Easy Mode – one-off settings before preparation

Touch and hold the image of a product for 2 seconds to access 'Easy Mode'. Now make one-off settings for the selected product. These settings are **not** saved. Then start preparation by tapping on the image of the product.

In the machine settings (programme item 'Easy Mode'), you can define whether the **caffeine content** or the **coffee strength** can be set in 'Easy Mode'.

Espresso and coffee

Example: Coffee

- Place a cup under the dual spout.



- Tap 'Coffee' (on page ●○○○○ in the world of indulgence 'Classic Hot Brew'). The preset amount of water for coffee flows into the cup.

Flat white ('Sweet Foam' world of indulgence)

- ▣ All specialities with milk can also be prepared with **sweet milk foam**. To do this, switch to the 'Sweet Foam' world of indulgence and use the syrup attachment supplied.

Precondition: Milk is connected to the dual spout.

- Swipe your finger from bottom to top across the start screen to access the selection of the worlds of indulgence.
- Tap 'Sweet Foam'. The start screen of the 'Sweet Foam' world of indulgence is displayed.
- Remove the cover from the syrup attachment.



- Fill the syrup attachment with syrup. Fill it to the first, second or third mark depending on the desired sweetness.
- Close the syrup attachment.
- Tap 'Flat White'.
- Remove the lower part of the milk system.

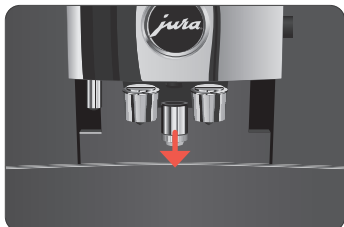

- Attach the syrup attachment to the milk system.

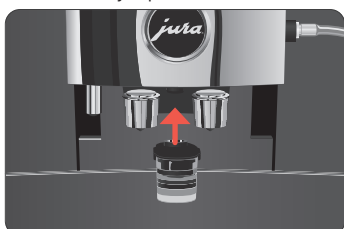

4 Preparation

- ▶ Place a cup under the dual spout.
- ▶ Touch **'Next'**.
The preset amounts of coffee and milk foam flow into the cup.
- ▶ Remove the syrup attachment and rinse it thoroughly under running water.

i The syrup attachment, including the cover, is dishwasher-safe.

- ▶ Refit the lower part of the milk system.

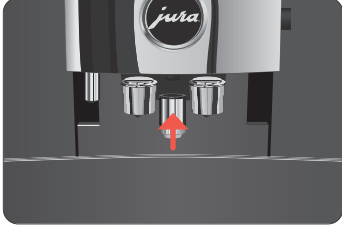

- ▶ Touch **'Next'**.

i **8 minutes** after preparation, the milk system is **automatically** rinsed. Therefore always place a receptacle under the dual spout after preparing milk.

To ensure that the milk system in the dual spout always works properly, you must clean it **daily** (see chapter 7 'Maintenance – Cleaning the milk system').

Coffee ('Cold Brew' world of indulgence)

i You can prepare many specialities as a **Cold Brew**. To do so, switch to the 'Cold Brew' world of indulgence.

- ▶ Fill the water tank with **cold** water.

i The temperature of the water in the water tank affects the brewing result. Use fresh, cold water.

- ▶ Add ice cubes to a glass according to your own preferences.
- ▶ Place the glass under the dual spout.

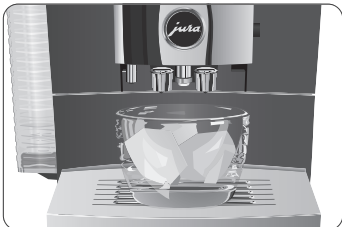

- ▶ Swipe your finger from bottom to top across the start screen to access the selection of the worlds of indulgence.
- ▶ Tap **'Cold Brew'**.
The start screen of the 'Cold Brew' world of indulgence is displayed.
- ▶ Tap **'Coffee'**.
The preset amount of water for the coffee flows into the glass.

Chocolate foam and mocaccino

The **chocolate attachment** for chocolate syrup enriches the 'Sweet Foam' world of indulgence available on your Z10 with chocolate foam for children or mocaccino.

Example: Chocolate foam

Precondition: Milk is connected to the dual spout.

- ▶ Swipe your finger from bottom to top across the start screen to access the selection of the worlds of indulgence.
- ▶ Tap **'Sweet Foam'**.
The start screen of the 'Sweet Foam' world of indulgence is displayed.
- ▶ Go to page **○●○** on the start screen.
- ▶ Remove the cover from the chocolate attachment.

- ▶ Fill the chocolate attachment with syrup.



- ▶ **i** Fill to the first, second, or third line: whether you want a light or full-bodied cocoa flavour, the amount of chocolate syrup determines the taste.
- ▶ Close the chocolate attachment.
- ▶ Tap **'Chocolate foam'**.
- ▶ Remove the lower part of the milk system.

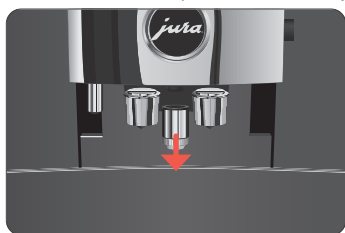

- ▶ Fit the chocolate attachment to the milk system.

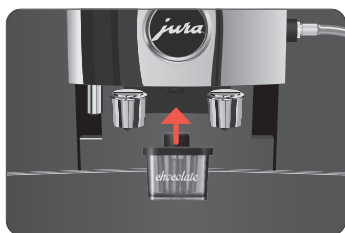

- ▶ Place a glass under the dual spout.
- ▶ Touch **'Next'**.
The preset amount of chocolate foam flows into the glass.
- ▶ Remove the syrup attachment and rinse it thoroughly under running water.

i The chocolate attachment, including the cover, is dishwasher-safe.

- ▶ Refit the lower part of the milk system.

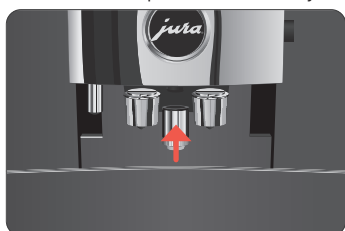

- ▶ Touch **'Next'**.

i **8 minutes** after preparation, the milk system is **automatically** rinsed. Therefore always place a receptacle under the dual spout after preparing milk.

To ensure that the milk system in the dual spout always works properly, you must clean it **daily** (see chapter 7 'Maintenance – Cleaning the milk system').

Latte macchiato, cappuccino and other speciality coffees with milk

Your Z10 prepares the following speciality coffees with milk at the touch of a button:

- **'Cappuccino'**
- **'Cortado'**
- **'Flat White'**
- **'Latte macchiato'**

4 Preparation

- 'Mocaccino'
- 'Espresso Macchiato'
- 'Caffè latte'

Example: Latte macchiato

Precondition: Milk is connected to the dual spout.

- Place a glass under the dual spout.



- Tap 'Latte macchiato' (on page ○●○○○ in the world of indulgence 'Classic Hot Brew'). The preset amounts of milk and milk foam flow into the glass.

i There is a short interval while the hot milk separates from the milk foam. This allows the typical layers of a latte macchiato to form. The preset amount of water for espresso flows into the glass.

i **8 minutes** after preparation, the milk system is **automatically** rinsed. Therefore always place a receptacle under the dual spout after preparing milk.

To ensure that the milk system in the dual spout always works properly, you must clean it **daily** (see chapter 7 'Maintenance – Cleaning the milk system').

Americano and special coffee

For the americano, special coffee and Long Black, the Z10 blends the coffee with hot water using a special preparation method. This results in a full-bodied speciality coffee which is particularly easy to digest. You can change the amount of this additional water (see chapter 4 'Preparation – Adjusting the product settings').

Espresso doppio

'Doppio' is Italian for 'double'. When you select Espresso doppio, two espressi are prepared one after the other. The result is an extra full-bodied and aromatic speciality coffee.

Pot of coffee

Relive the good old days – a 'pot of coffee', traditionally made from porcelain, is perfect when you want to slow things down and catch up with friends or family. The 'pot of coffee' function provides a large portion of black coffee which is generally served at breakfast or to accompany a piece of cake. Select between 1–5 strokes of black coffee.

You can change the coffee strength and quantity during the first stroke. All further strokes are then prepared with these settings.

Ground coffee

You can choose to use a second coffee variety, for example decaffeinated coffee, with the filter funnel for ground coffee.

Basic information about ground coffee:

- Never add more than two level measuring spoons of ground coffee.
- Use ground coffee which is not ground too finely. Very fine coffee can block up the system so that the coffee only comes out in drips.
- If you did not fill the machine with a sufficient amount of ground coffee, 'Not enough ground coffee' is displayed and the Z10 stops the operation.
- The desired speciality coffee must be prepared within approximately one minute after filling with the ground coffee. Otherwise the Z10 stops the operation and is once more ready for use.
- All speciality coffees with ground coffee are always prepared following the same model.

Example: Espresso with ground coffee

- Place a cup under the dual spout.
- Tap **for approx. 2 seconds** on 'Espresso' to call up 'Easy Mode'.
- Tap on the preselection ☕.
- Tap the image of the espresso to start preparation.

- ▶ Open the powder chute cover.

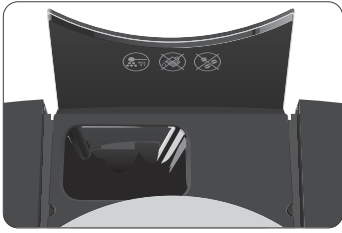

- ▶ Add the desired amount of ground coffee to the filler funnel (max. 2 level measuring spoons).

i The amount of ground coffee determines the intensity and aroma of the beverage, so you can adjust it to your personal preferences.

- ▶ Close the cover.
 - ▶ Touch 'Next'.
- The preset amount of water for espresso flows into the cup.

Hot water

The Z10 allows you to prepare different variants of hot water:

- 'Hot water'
- 'Hot water for green tea'

⚠ CAUTION

There is a danger of scalding from hot water splashes.

- ▶ Avoid direct contact with the skin.

Example: Hot water

- ▶ Place a cup under the dual spout.





- ▶ Tap 'Hot water' (on page ○○○○●).
- The preset amount of water flows into the cup.

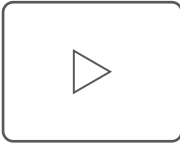

Adjusting the product settings



Tap, click or scan to watch
the video tutorial on YouTube



Tap and hold a product for **approximately 2 seconds** and then tap  to access the settings:

- 'Product settings': Specify individual settings such as coffee strength, amount of water, etc.
- 'Product name': Change the name of the product.
- 'Permanent preselection': Make a permanent preselection ('ground coffee'  or 'double product' .
- 'Product position'
 - 'Replace product': replace a product with any product from the product selector.
 - 'Change position': swap the position of two products.
 - 'Add product': add a product. The products after this one move down one position.
 - 'Remove product': remove a product. The products after this one move up one position.

Example: Proceed as follows to change the coffee strength for one coffee.

- ▶ Tap 'Coffee' for **approximately 2 seconds**.
- ▶ Tap .

5 Daily operation

- ▶ Tap 'Product settings'.

i Depending on the selected product, different settings will be available which are represented by symbols on your display.

- ▶ Tap the coffee bean symbol.
- ▶ Swipe across the coffee beans with your finger to change the coffee strength setting.
- ▶ Touch 'Save'.
- ▶ Touch 'Back' to return to the start screen.

5 Daily operation

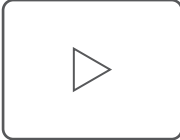

Tap, click or scan to watch
the video tutorial on YouTube



Switching the machine on and off

- ▶ Place a receptacle under the dual spout.

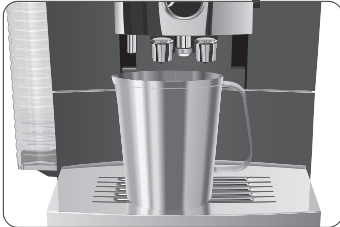

- ▶ Press the On/Off button .

'Machine is rinsing'

Your Z10 is switched on or off.

i When the machine is switched off, the system is only rinsed if a speciality coffee has been prepared.

i If milk has been prepared before switching off, you will be prompted to carry out milk system cleaning ('Milk system cleaning'). After 30 seconds, the switch-off process continues automatically.

Filling the water tank

Daily maintenance of the machine and hygiene when handling coffee and water are key to a perfect coffee result in the cup every time. You should therefore change the water **daily**.

CAUTION

Milk, sparkling mineral water or other liquids can damage the water tank or the machine.

- ▶ Only fill the water tank with fresh, cold water.
- ▶ Remove the water tank and rinse it with cold water.
- ▶ Fill the water tank with fresh, cold water and reinsert the tank.

Maintenance actions

Optimal coffee quality depends on many factors. One important prerequisite is regular maintenance of your Z10. Carry out the following steps:

Maintenance action	Daily	If necessary	Note
Empty the drip tray and coffee grounds container and rinse with warm water (The insert for the drip tray, including the drip tray itself, and the coffee grounds container are dishwasher-safe)	▪		Always empty the coffee grounds container when the machine is switched on. This is the only way of resetting the coffee grounds counter.



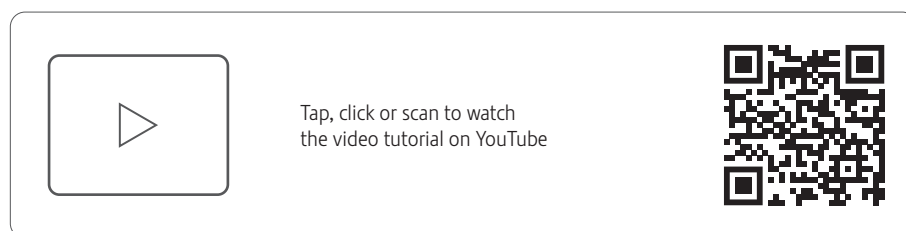

Maintenance action	Daily	If necessary	Note
Clean the milk system (if heavily soiled, also dismantle and rinse it)		▪	See chapter 7 'Maintenance – Cleaning the milk system'. We recommend dismantling and rinsing the dual spout once a week (see chapter 7 'Maintenance – Dismantling and rinsing the dual spout').
Rinse the milk pipe	▪		
Rinse the water tank	▪		
Wipe the surface of the machine with a clean, soft, damp cloth (e.g. microfibre cloth)	▪		
Changing milk pipe with connector HP3		approx. every 3 months	
Change the interchangeable milk spout CX3		approx. every 3 months	
Clean the inside of the water tank with a brush		▪	
Clean the top and bottom of the cup grille		▪	
Thoroughly clean the drip tray and coffee grounds container		▪	

i You will find more information about the maintenance of your Z10 in the 'Maintenance'  area in programme item 'Maintenance information'.

6 Machine settings







Tap  at the top right or press the Rotary Switch to access the Cockpit. The following settings can be made in 'Machine Settings' .

Programme item	Explanation
Page  	
'Choose language'	Set language Use J.O.E.®, your JURA app, to download additional languages.
'Water hardness'	Set the hardness of the water used (1 °dH to 30 °dH) to prevent limescale building up in your machine
'Display brightness'	Change display brightness (in 10% increments)
'Switch off after'	To save energy, the switch-off time is set to 30 minutes ex-works. Possible settings: Switch-off after 15 minutes, 30 minutes or 1-9 hours after the last action on the machine. If you extend the switch-off time, you therefore accept a high energy consumption. Energy consumption of the Z10 when switched off: 0 Watt.
'Start-up world'	Define whether selection of the world of indulgence should be queried each time the machine is switched on
'Easy Mode'	Define whether the caffeine content or the coffee strength can be set in 'Easy Mode'
'Quality Assistant'	The Quality Assistant supports you in the operation and maintenance of your Z10 – for a long service life and optimum coffee quality at all times (active/inactive)
'Operating instructions'	Show instructions regarding use of the chocolate attachment/syrup attachment (active/inactive)
Page  	
'Connect to milk cooler'	Establish a wireless connection between your Z10 and the Cool Control milk cooler or disconnect it again
'Connect to J.O.E.'	Wirelessly connect the Z10 to the JURA app (J.O.E.®) or disconnect again (see chapter 3 'Preparing and using for the first time – Connect the machine with J.O.E.® - your JURA app')
'Units'	Set the unit for the amount of water (ml or oz)
'Factory settings'	Reset your Z10 to factory settings (the machine then switches off)
'Empty system'	Empty the system to protect the Z10 from frost damage during transport (see chapter 10 'Transport and environmentally friendly disposal – Transport / Emptying the system')
'Product counter'	View product counter

Programme item	Explanation
'Maintenance counter'	View the maintenance counter
'Version'	View software version

7 Maintenance

Basic information about maintenance:

- Tap  at the top right or press the Rotary Switch to access the Cockpit. This consists of a 'Maintenance status'  section and a 'Machine settings'  section. You can manage the maintenance of your Z10 in the  section.
- The Cockpit shows maintenance programmes that need to be carried out in the form of messages with red backgrounds. Touch a message to go straight to the corresponding maintenance programme. Maintenance programmes that are due imminently are indicated on your Z10 by means of a bar display within the message.
- Carry out each maintenance programme when you are prompted to do so.

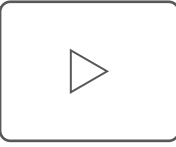

Cleaning the milk system



Tap, click or scan to watch
the video tutorial on YouTube





To ensure that the milk system in the dual spout always works properly, you must clean it **daily** when you have been preparing milk.

-  JURA milk system cleaner is available from specialised dealers.
-  To clean the milk system, use the container supplied.

Precondition: The start screen is displayed.

- Tap  at the top right or press the Rotary Switch to access the Cockpit.
- Tap 'Milk system cleaning'.
- Touch 'Start'.
- Now follow the instructions on the display.

-  Amount of milk system cleaner required: 1 dosing unit.
-  To connect the milk pipe to the container correctly, the pipe must be fitted with a connector HP3.

Dismantling and rinsing the dual spout

If insufficient foam is produced when the milk is frothed or milk sprays out of the dual spout, the spout may be dirty. If this happens, dismantle and rinse the dual spout.

-  We recommend dismantling and rinsing the dual spout once a week.
- Remove the milk pipe and rinse it thoroughly under running water.

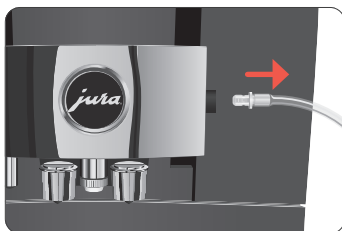

- Press the releasing devices and pull the cover of the dual spout up and off.



- Remove the milk system from the dual spout.

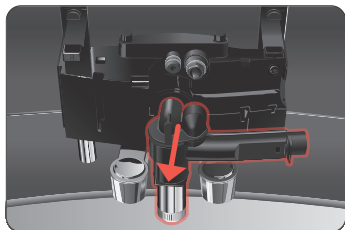

- i** Do not lever the milk system back and forth to disconnect it from the milk pipe connection. Remove the milk system firmly to prevent it from tilting.

- Dismantle the milk system into its individual parts.

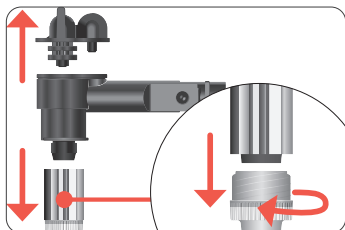

- Rinse all the parts under running water. If there are severely dried-on milk residues, firstly immerse the individual parts in a solution of 250 ml water and one dosing unit of JURA milk system cleaner. Then rinse the individual parts thoroughly.
- Reassemble the milk system.

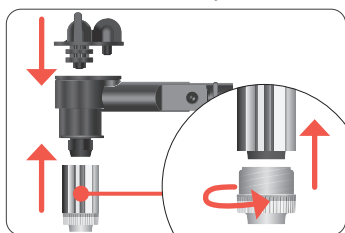

- Fit the assembled individual parts back in the dual spout and press it firmly.

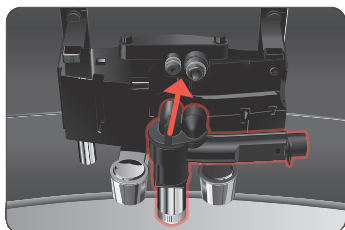

- Fit the cover of the dual spout. Make sure the cover of the dual spout is correctly engaged.

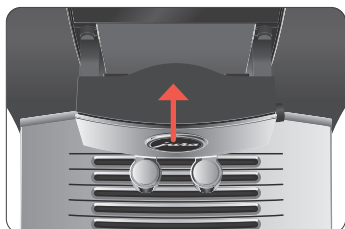

Inserting/changing the filter

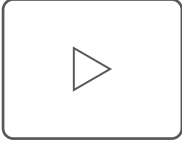

Tap, click or scan to watch
the video tutorial on YouTube



Once the filter cartridge stops working (depending on the water hardness setting), the Z10 will prompt you to change the filter.

- i** Your Z10 no longer has to be descaled if you are using the CLARIS Smart+ filter cartridge.
- i** CLARIS Smart+ filter cartridges are available from specialised dealers.

Precondition: 'Filter change' is displayed in the Cockpit.

- Tap  at the top right or press the Rotary Switch to access the Cockpit.
- Tap 'Filter change'.
- Touch 'Start'.
- Now follow the instructions on the display.

Cleaning the machine



Tap, click or scan to watch
the video tutorial on YouTube



After 180 preparations or 80 switch-on rinses, the Z10 will prompt you to clean it.

- i** The cleaning programme lasts approximately 20 minutes.
- i** Do not interrupt the cleaning programme. The quality of cleaning will be impaired if you do so.
- i** JURA cleaning tablets are available from specialised dealers.

Precondition: 'Cleaning' is displayed in the Cockpit.

- Fill the water tank.
- Tap  at the top right or press the Rotary Switch to access the Cockpit.
- Tap 'Cleaning'.
- Touch 'Start'.
- Now follow the instructions on the display.

- i** You need 1 JURA cleaning tablet.

Descaling the machine



Tap, click or scan to watch
the video tutorial on YouTube



The Z10 builds up deposits of limescale over time and automatically prompts you to descale it when necessary. The degree of calcification depends on the hardness of your water.

- i** If you are using a CLARIS Smart+ filter cartridge, you will not be prompted to descale.
- i** The descaling programme lasts approximately 20 minutes.
- i** JURA descaling tablets are available from specialised dealers.

Precondition: 'Descaling' is displayed in the Cockpit.

- Tap  at the top right or press the Rotary Switch to access the Cockpit.

- Tap 'Descaling'.
- Touch 'Start'.
- Now follow the instructions on the display.

i You need 3 JURA descaling tablets.

i If the descaling operation stops unexpectedly, rinse the water tank thoroughly.

Descaling the water tank

Limescale deposits may form in the water tank. To ensure correct function of the machine, descale the water tank from time to time.

- Remove the water tank.
- If you use a CLARIS Smart+ filter cartridge, remove this.
- Completely fill the water tank and dissolve 3 JURA descaling tablets in it.
- Leave the water tank with the descaling solution for several hours (e.g. overnight).
- Empty the water tank and rinse it thoroughly.
- If you use a CLARIS Smart+ filter cartridge, insert this again.
- Fill the water tank with fresh, cold water and reinsert the tank.

Cleaning the bean container

Coffee beans may be covered with a slight oil film which remains on the walls of the bean container. These traces may negatively affect the coffee result. For this reason clean the bean container from time to time.

Precondition: 'Fill bean container' is displayed.

- Switch the machine off with the On/Off button .
- Remove the aroma preservation cover.
- Clean the bean container with a soft, dry cloth.
- Fill the bean container with coffee beans and close the aroma preservation cover.

8 Display messages

Messages on the start screen

Message	Cause/Result	Action
'Fill water tank'	The water tank is empty. You cannot prepare any products.	▸ Fill the water tank (see chapter 5 'Daily operation – Filling the water tank').
'Empty grounds' / 'Empty drip tray'	The coffee grounds container is full. / The drip tray is full. You cannot prepare any products.	▸ Empty the coffee grounds container and the drip tray (see chapter 5 'Daily operation – Maintenance actions').
'Drip tray not fitted'	The drip tray is not inserted correctly or is not inserted at all. You cannot prepare any products.	▸ Fit the drip tray.
'Fill bean container'	The bean container is empty. You cannot prepare any speciality coffees, but you can prepare hot water and milk.	▸ Fill the bean container (see chapter 3 'Preparing and using for the first time – Filling the bean container').
'Not enough ground coffee'	There is insufficient ground coffee in the machine; the Z10 stops the operation.	▸ The next time you prepare a beverage, add more ground coffee (see chapter 4 'Preparation – Ground coffee').
'Spout is not fitted'	The cover of the dual spout has not been fitted.	▸ Correctly fit the cover of the dual spout.

Messages in the Cockpit

Message	Cause/Result	Action
The filter symbol  lights up red. 'Filter change'	The filter cartridge is used up.	▸ Replace the CLARIS Smart+ filter cartridge (see chapter 7 'Maintenance – Inserting/changing the filter').
'Cleaning'	The Z10 is prompting you to clean it.	▸ Perform cleaning (see chapter 7 'Maintenance – Cleaning the machine').
'Descaling'	The Z10 is prompting you to descale it.	▸ Perform descaling (see chapter 7 'Maintenance – Descaling the machine').
'Milk system cleaning'	The Z10 prompts you to clean the milk system.	▸ Perform milk system cleaning (see chapter 7 'Maintenance – Cleaning the milk system').

9 Troubleshooting

Problem	Cause/Result	Action
Insufficient foam is produced when the milk is frothed or milk sprays from the dual spout.	The dual spout is dirty.	<ul style="list-style-type: none"> ▸ Make sure the cover of the dual spout is correctly fitted. ▸ Clean the milk system in the dual spout (see chapter 7 'Maintenance – Cleaning the milk system'). ▸ Dismantle and rinse the dual spout (see chapter 7 'Maintenance – Dismantling and rinsing the dual spout').
	The milk and milk foam temperature is set too high.	<ul style="list-style-type: none"> ▸ Set a lower milk and milk foam temperature for the product.
With speciality coffees with a finer grinder setting, the coffee only flows in drips.	The coffee has been ground too finely and is blocking the system.	<ul style="list-style-type: none"> ▸ If possible, set the consistency of grind for the speciality coffee 1–2 levels coarser.
Coffee only comes out in drips when it is being prepared.	The coffee has been ground too finely and is blocking the system.	<ul style="list-style-type: none"> ▸ Use more coarsely ground coffee (see chapter 4 'Preparation – Ground coffee').
	The water hardness may not have been correctly set.	<ul style="list-style-type: none"> ▸ Perform descaling (see chapter 7 'Maintenance – Descaling the machine').
There is dry ground coffee behind the coffee grounds container.	The beans used are resulting in an above-average volume of ground coffee.	<ul style="list-style-type: none"> ▸ Reduce the coffee strength or choose a finer grinder setting (see chapter 4 'Preparation – Adjusting the product settings').
'Fill water tank' is not displayed although the water tank is empty.	There is a lot of limescale in the water tank.	<ul style="list-style-type: none"> ▸ Descale the water tank (see chapter 7 'Maintenance – Descaling the water tank').
Grinder is making a very loud noise.	There are foreign objects in the grinder.	<ul style="list-style-type: none"> ▸ Contact customer support in your country (see chapter '13 JURA contact details / Legal information').
'ERROR 2' or 'ERROR 5' is displayed.	If the machine has been exposed to the cold for a long period of time, heating may be disabled for safety reasons.	<ul style="list-style-type: none"> ▸ Warm the machine at room temperature.
Other 'ERROR' messages are displayed.	–	<ul style="list-style-type: none"> ▸ Switch the Z10 off using the On/Off button. Contact customer support in your country (see chapter '13 JURA contact details / Legal information').
Little or no steam comes out of the dual spout. The pump is very quiet.	The connector of the milk system in the dual spout may be blocked by milk residues or limescale fragments loosened during descaling.	<ul style="list-style-type: none"> ▸ Press the releasing devices and pull the cover of the dual spout up and off. ▸ Remove the milk system from the dual spout. ▸ Unscrew the black connector with the aid of the hexagonal hole on the measuring spoon for ground coffee. ▸ Clean the connector thoroughly. ▸ Screw the connector back on by hand. ▸ Carefully tighten it using the hexagonal hole on the measuring spoon, turning by no more than a quarter of a rotation.

i If you were unable to solve the problem, contact customer support in your country (see chapter '13 JURA contact details / Legal information').

10 Transport and environmentally friendly disposal

Transport / Emptying the system



Keep the packaging for your Z10. It should be used to protect the machine during transport.

In order to protect the Z10 from frost during transport, the system must be emptied.

Precondition: The start screen is displayed.

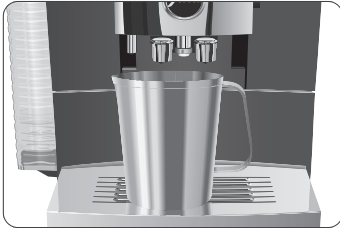
- Remove the milk pipe from the dual spout.
- Place a receptacle under the dual spout.



- Tap  at the top right or press the Rotary Switch to access the Cockpit.
 - Tap the 'Machine settings' symbol .
 - Tap '1/2' at the top right to open the second page of the settings.
 - Tap 'Empty system'.
 - Remove and empty the water tank.
 - Touch 'Next'.
- Steam will continue to be discharged from the dual spout and the hot-water nozzle until the system is empty.
Your Z10 is switched off.



Disposal

Please dispose of old machines in an environmentally neutral way.



Old machines contain valuable, recyclable materials which should be recycled. Please therefore dispose of old machines via suitable collection systems.

11 Technical data

Voltage	220–240 V ~, 50 Hz
Power	1450 W
Conformity mark	 
Pump pressure	static, max. 15 bar
Holding capacity of water tank	2.4 l
Holding capacity of bean container	280 g
Holding capacity of coffee grounds container	max. 20 portions
Cable length	approx. 1.1 m
Weight	12,0–12,3 kg (depending on machine version)
Dimensions (W × H × D)	32 × 36,3 × 47 cm
Milk system with connector	HP3
Interchangeable milk spout	CX3
CLARIS Smart+ filter cartridge (RFID technology)	Frequency band 13.56 MHz Max. transmission power < 1 mW
JURA Wi-Fi Connect (Wi-Fi connection)	Frequency band 2.4 GHz Max. transmission power < 100 mW
JURA type	778

Information for testers (repeat test in accordance with DIN VDE 0701-0702): The central grounding point (CGP) is located on the back of the machine, right next to the mains cable's connection point.

12 Index

A

- Addresses 25
- Adjusting the product settings 15
- Americano 14
- Aroma preservation cover
 - Bean container with aroma preservation cover 3

B

- Bean container
 - Bean container with aroma preservation cover 3
 - Cleaning 21
 - Filling 6
- Bus bar
 - Technical data 23
- Button
 - On/Off button 3

C

- Caffè latte 13
- Cappuccino 13
- Central grounding point 23
- Children 4
- Chocolate attachment 3, 12
- Chocolate foam 12
- CLARIS Smart filter cartridge
 - Changing 20
 - Inserting 20
- Cleaning
 - Bean container 21
 - Machine 20
- Cockpit 8, 17, 18
- Coffee 11
- Coffee grounds container 3
- Cold Brew 12
- Contact details 25
- Cup grille 3
- Customer support 25

D

- Damage
 - Preventing damage 5
 - What to do in the event of damage 4
- Declaration of Conformity 25
- Descaling
 - Machine 20
 - Water tank 21
- Display
 - Cockpit 8
 - Touch display 3
- Display messages 21
- Disposal 23
- Drip tray 3
- Dual spout
 - Dismantling and cleaning 18
 - Height- and width-adjustable dual spout 3

E

- Emptying the system 23
- Errors
 - Troubleshooting 22
- Espresso 11
- Espresso doppio 14
- EU Declaration of Conformity 25

F

- Filling
 - Bean container 6
 - Water tank 16
- Filter
 - Changing 20
 - Inserting 20

- Filter casing 3
- First-time use 6
- Flat white 11, 13

G

- Ground coffee 14
 - Measuring spoon for ground coffee 3
 - Powder chute for ground coffee 3
- Grounding point 23

H

- Hotline 25
- Hot water 15
- Hot-water spout 3

I

- Instant coffee
 - Ground coffee 14
- Interchangeable milk spout 23

J

- JURA
 - Contact details 25

L

- Latte macchiato 13
- Long Black 14

M

- Macchiato 13
- Machine
 - Cleaning 20
 - Descaling 20
 - Setting up 6
- Machine settings 17
- Mains cable 3
- Maintenance 18
- Maintenance actions 16
- Measuring spoon for ground coffee 3
- Messages, display 21
- Milk
 - Connecting milk 8
- Milk system 23
 - Chocolate attachment 12
 - Clean 18
 - Syrup attachment 3, 11

P

- Pot of coffee 14
- Powder chute
 - Powder chute for ground coffee 3
- Preparation 10, 13
 - Americano 14
 - Caffè latte 13
 - Cappuccino 13
 - Chocolate foam 12
 - Coffee 11
 - Cold Brew 12
 - Espresso 11
 - Espresso doppio 14
 - Flat white 11, 13
 - Ground coffee 14
 - Hot water 15
 - Latte macchiato 13
 - Long Black 14
 - Macchiato 13
 - Mocaccino 12
 - Pot of coffee 14
 - Special coffee 14
- Problems
 - Troubleshooting 22

Product settings
 Adjusting 15
 Proper use 4

R

RFID 23
 Rotary Switch 3

S

Safety information 4
 Service socket 3
 Setting up
 Setting up the machine 6
 Special coffee 14
 Spout
 Height- and width-adjustable dual spout 3
 Hot-water spout 3
 Switching off 16
 Switching on 16
 Symbol description 4
 Syrup attachment 3, 11

T

Technical data 23
 Interchangeable milk spout 23
 Milk system 23

Tel 25
 Touch display 3
 Transport 23
 Troubleshooting 22

U

Use, First-time 6
 Users 4

W

Water hardness
 Determining the water hardness 6
 Water tank 3
 Descaling 21
 Filling 16
 Wi-Fi 23
 Wi-Fi Connect 3, 9
 Wi-Fi connection 9
 Wireless connection 9, 20, 23

13 JURA contact details / Legal information

JURA Elektroapparate AG
 Kaffeeweltstrasse 10
 CH-4626 Niederbuchsiten
 Tel. +41 (0)62 38 98 233

- i** You can find additional contact details for your country at jura.com.
- i** If you need assistance with using your machine, you can find this at jura.com/service.
- i** Your opinion is important to us! Use the contact details at jura.com.

Directives

The machine complies with the following directives:

- 2014/35/EU – Low Voltage Directive
- 2014/30/EU – Electromagnetic Compatibility
- 2009/125/EC – Ecodesign Directive
- 2011/65/EU – RoHS Directive
- 2014/53/EU – Wireless Voltage Directive

A detailed EU Declaration of Conformity for your Z10 can be found at jura.com/conformity.

Technical changes

We reserve the right to make technical changes. The diagrams used in these instructions for use are for illustration purposes only and do not represent the original colours of the machine. Some details of your Z10 may vary.